

Owner's Manual

X-28H

MULTITRACKER

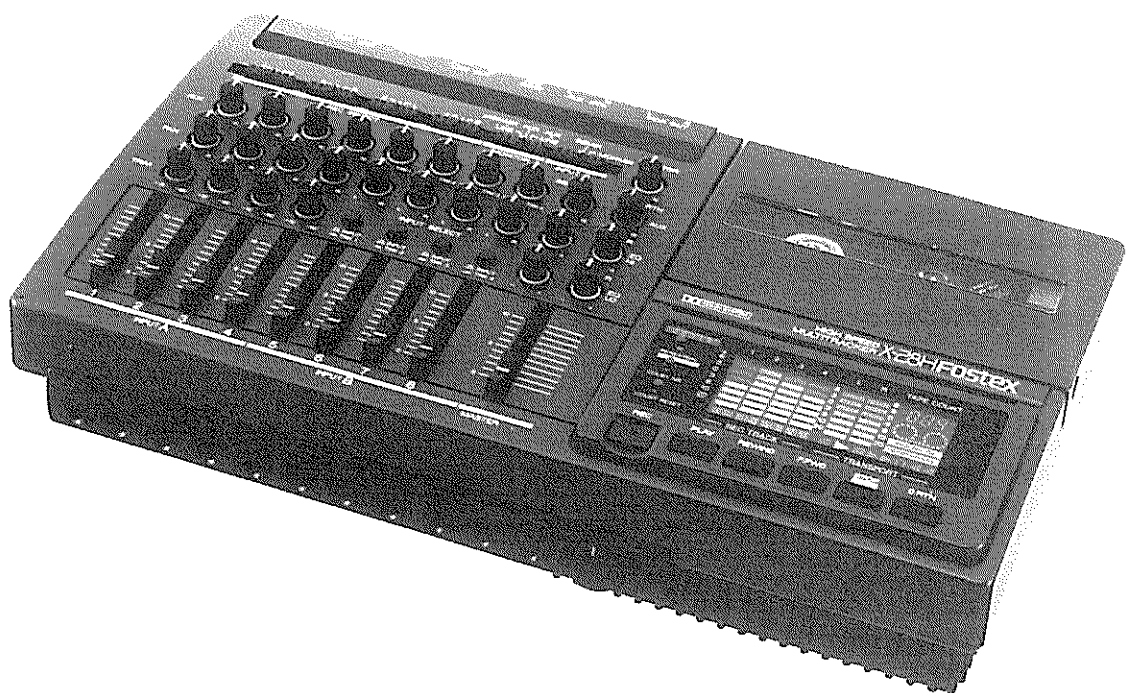

Fostex[®]

見本

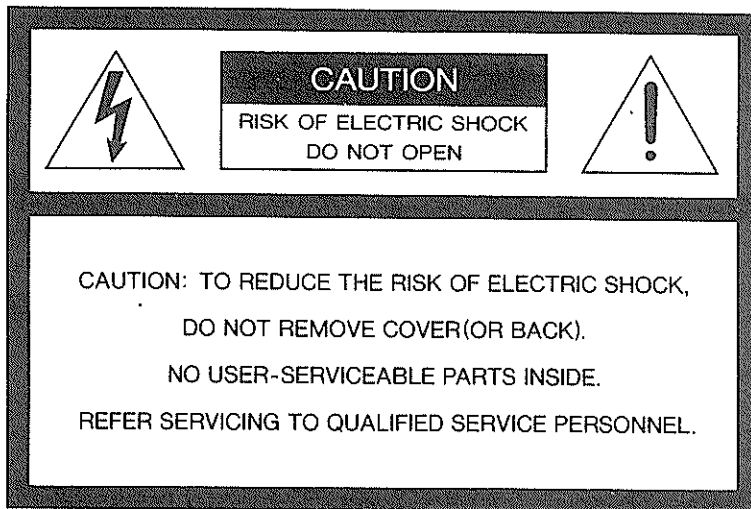

The lightning flash with arrowhead symbol, within an equilateral triangle, is intended to alert the user to the presence of uninsulated "dangerous voltage" within the product's enclosure that may be of sufficient magnitude to constitute a risk of electric shock to persons.

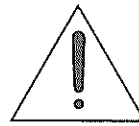

The exclamation point within an equilateral triangle is intended to alert the user to the presence of important operating and maintenance (servicing) instructions in the literature accompanying the appliance.

"WARNING"

"TO REDUCE THE RISK OF FIRE OR ELECTRIC SHOCK, DO NOT EXPOSE THIS APPLIANCE TO RAIN OR MOISTURE."

SAFETY INSTRUCTIONS

1. Read Instructions — All the safety and operating instructions should be read before the appliance is operated.
2. Retain Instructions — The safety and operating instructions should be retained for future reference.
3. Heed Warnings — All warnings on the appliance and in the operating instructions should be adhered to.
4. Follow Instructions — All operating and use instructions should be followed.
5. Water and Moisture — The appliance should not be used near water — for example, near a bathtub, washbowl, kitchen sink, laundry tub, in a wet basement, or near a swimming pool, and the like.
6. Carts and Stands — The appliance should be used only with a cart or stand that is recommended by the manufacturer.
7. Wall or Ceiling Mounting — The appliance should be mounted to a wall or ceiling only as recommended by the manufacturer.
8. Ventilation — The appliance should be situated so that its location or position does not interfere with its proper ventilation. For example, the appliance should not be situated on a bed, sofa, rug, or similar surface that may block the ventilation openings; or, placed in a built-in installation, such as a bookcase or cabinet that may impede the flow of air through the ventilation openings.
9. Heat — The appliance should be situated away from heat sources such as radiators, heat registers, stoves, or other appliances (including amplifiers) that produce heat.
10. Power Sources — The appliance should be connected to a power supply only of the type described in the operating instructions or as marked on the appliance.
11. Grounding or Polarization — The precautions that should be taken so that the grounding or polarization means of an appliance is not defeated.
12. Power Cord Protection — Power supply cords should be routed so that they are not likely to be walked on or pinched by items placed upon or against them, paying particular attention to cords at plugs, convenience receptacles, and the point where they exit from the appliance.
13. Cleaning — The appliance should be cleaned only as recommended by the manufacturer.
14. Nonuse Periods — The power cord of the appliance should be unplugged from the outlet when left unused for a long period of time.
15. Object and Liquid Entry — Care should be taken so that objects do not fall and liquids are not spilled into the enclosure through openings.
16. Damage Requiring Service — The appliance should be serviced by qualified service personnel when:
 - A. The power supply cord or the plug has been damaged; or
 - B. Objects have fallen, or liquid has been spilled into the appliance; or
 - C. The appliance has been exposed to rain; or
 - D. The appliance does not appear to operate normally or exhibits a marked change in performance; or
 - E. The appliance has been dropped, or the enclosure damaged.
17. Servicing — The user should not attempt to service the appliance beyond that described in the operating instructions. All other servicing should be referred to qualified service personnel.



An appliance and cart combination should be moved with care. Quick stops, excessive force, and uneven surfaces may cause the appliance and cart combination to overturn.

TABLE OF CONTENTS

Introduction	2	Punch-in Recording	21
Safety Precautions	3	Special Applications	24
How to Use This Manual	3	Example 1: Simultaneous Stereo Recording of Eight Sound Sources	24
Before Using Your X-28H Multitracker	4	Overdubbing Tracks to the Live Stereo Recording	25
What is Multitrack Recording?	4	Example 2: Ping-pong Recording — Recording Seven Parts on Four Tracks	25
Block Diagram	6	Adding Live Parts to Ping-pong Recording ...	26
Panel Controls and Terminals	8	Helpful Hints for Ping-pong Recording	27
Basic Operation	13	Example 3: Tape Sync	28
Recording the First Track — Rhythm Machine ..	14	Tape Sync — Combining Ten MIDI Inputs With Three Tape Tracks	30
Monitoring	16	Multitrack Recording Tips	31
Four-track Simultaneous Recording	16	Routine Maintenance	33
Buss	17	Troubleshooting Guide	34
Overdubbing — Recording Bass to Track 2 and Keyboard to Track 3	18	Specifications	34
Overdubbing the Final Track — Vocal and Guitar	18		
Mono Monitoring in Stereo Recording	18		
Mixdown and Effects Processing — Adding Reverb	19		
AUX (Auxiliary) Send and Return	20		

INTRODUCTION

Thank you for purchasing the Fostex Model X-28H Multitracker. With proper use and maintenance it will provide years of excellent performance.

Included among the features and functions of the X-28H are:

- An eight-input mixer with four gain-adjustable mic/line inputs and four line inputs, all of which can be used for simultaneous recording.
- Logic-controlled transport buttons for ease of use and sure transport control.
- A large, backlit LCD display that features a digital tape counter, meters for all four tape tracks and stereo outputs, and tape transport indicators.
- A rehearsal function, in the punch-in/out mode, that allows you to hear and practice a punch-in recording before the actual take.
- Switchable Dolby B noise reduction.

- Four-track simultaneous recording.

The X-28H will perform all of the standard multitrack recording techniques, such as overdubbing, punch-in recording and ping-pong recording. In addition, effects processing is available with the AUX send and stereo AUX return functions.

The high speed setting (9.5 cm/sec) is intended for normal use. The half speed setting (4.75 cm/sec) is useful when practicing along with or learning parts from a recording, since playback is one octave lower than normal.

When used with a MIDI-to-FSK converter, the operation of the X-28H can be synchronized with MIDI sequencers and rhythm machines, allowing you to simultaneously run multiple musical instruments and signal sources.

Please read this manual carefully so that you are thoroughly acquainted with the proper operation and maintenance procedures.

SAFETY PRECAUTIONS

- Connect the supplied AD-12T AC adaptor to a standard AC outlet and the AC adaptor connector of the X-28H. **In no case should you use an AC adaptor of another manufacturer.** If this adaptor is to be used with a voltage other than that specified, consult your nearest Fostex dealer or service center before using it.
- **Never pull the cord of the AC adaptor** to unplug it from the AC outlet; always grasp the AC plug itself when disconnecting. The cord can be broken if it is pulled directly.
- Never connect or disconnect the AC adaptor when your hands are wet. Neither should you use this product if the cord's insulation is damaged or worn. In either case, doing so may result in electrical shock.
- Never open the case and touch anything inside. Doing so may result in electrical shock or damage to the unit.
- Be careful not to spill any water or liquids or drop any metal objects inside the unit. This could also result in electrical shock. If water or anything should accidentally get inside, immediately disconnect the AC adaptor from the outlet and contact your nearest Fostex dealer or service center.
- Be sure to turn the power to this unit on first before switching on the power to other connected equipment, in order to avoid damaging them. Also, when connecting or disconnecting any input or output plugs, make sure that the input volume control of the appropriate channel or buss is set to 0.

HOW TO USE THIS MANUAL

If you are using a multitrack recorder for the first time, we recommend that you read through this manual in the following order. In this way, you can get the most out of your X-28H.

- 1) Please read the section "Before Using Your X-28H Multitracker", on page 4. This introduces you to the basic concepts of multitrack recording.
- 2) Go directly to the "Basic Operation" section, page 13, and follow the instructions there carefully. They will show you, step by step, how to make and mixdown your first recording. When you read through this section, you may wish to refer back to the section, "Panel Controls and Terminals", page 7. This will help you to understand the functions of the X-28H.
- 3) As you continue to use the X-28H for other recordings, read through the successive sections, including "Punch-in Recording" and "Special Applications", to familiarize yourself with the more sophisticated functions of this machine.
- 4) Also, read through the various boxed subjects scattered throughout the instructions to help you master some of the important aspects of multitrack recording. They include valuable information on such topics as buss, monitoring and aux send.
- 5) Finally, look through the section "Multitrack Recording Tips", page 31, for special tips and hints on how to make your recording sound as professional as possible.

For those of you who are complete novices in the field of recording, we hope this manual will be more than merely a guide to the X-28H. In many ways, with the information provided on basic recording concepts and advanced applications, this manual may be used as a textbook for multitrack recording.

BEFORE USING YOUR X-28H MULTITRACKER

Undoubtedly, you are eager to start recording with your X-28H Multitracker. However unless you've had some experience with multitrack recording, we recommend you take some time to read this section and familiarize yourself with multitrack recording basics.

WHAT IS MULTITRACK RECORDING?

Multitrack recording is the process of recording individual parts of a performance separately on independent tracks and then mixing them together to create a final recording. There are several advantages to this process. You can record each musician separately, without having to assemble them all together at the same place and time; you are able to concentrate on the individual elements so that each part is the best it can be; you can also try several different mixes of the recorded material until you are satisfied with the final production. Best of all, if you wish, you can do everything yourself. There is nothing wrong with recording a good, tight band with two well-placed microphones, but with the sophisticated technology available today, including MIDI, multitrack recording allows you to make highly professional recordings on your own.

Tracks and Channels

The X-28H Multitracker combines sophisticated recording and mixing functions in the same unit. Hence, the need for the terms "track" and "channel" when referring to its operation. "Track" refers to the actual recorded portion on the cassette tape; the X-28H records on four tracks. "Channel" refers to a signal pathway through the mixer; the X-28H has eight channels to accommodate up to eight inputs. The difference between the two terms is shown in the diagram below.

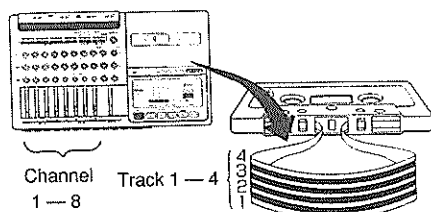

Overdubbing

Overdubbing is the heart of the multitrack recording process. It is the process of recording a track in synchronization to previously recorded tracks. Overdubbing was invented by Les Paul in collaboration with Ampex audio engineers in the 1950's, and has had a greater effect on music than the guitar which bears his name.

Used with the four independent tracks of the X-28H, overdubbing allows one musician to record a variety of parts on the same tape. In this way, you can build your songs piece by piece, track by track. It also lets you "fix" any parts that are not satisfactory, as well as independently apply special effects with signal processing equipment.

Mixdown

Mixdown is the final operation in multitrack recording. This is where you combine all of the parts you have recorded on the four tracks, adjust their relative levels and make other settings to prepare the final master recording.

Four-track Cassette Format

The X-28H uses standard cassette tape for recording. In a standard cassette deck, the tape has two sides, each side with a pair of stereo tracks. As shown in the illustration below, the two tracks on side A of the tape are recorded in one direction, and the tracks on side B in the opposite direction. However, the four-track cassette format records all four tracks in the same direction. Because of this, there is only one side to the four-track cassette tape; if you turn it over and play it, all you'll hear is a recording played in reverse. Because it is recorded on just one side, a 90 minute cassette tape will hold 22.5 minutes of four-track audio at high speed. Remember to remove the tabs for both side A and side B to protect against inadvertent recording.

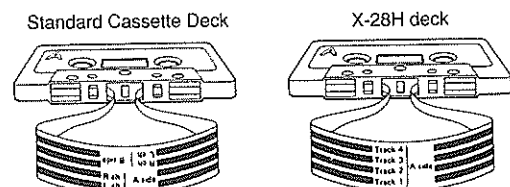

The Proper Tape

The X-28H is designed to be used with High Bias 70 μ sec EQ tape. CrO₂ and Type II designations are common, but always look for the 70 μ sec EQ identification. Maxell UD-XL II and TDK SA are recommended, as are other tapes of comparable quality. Metal tape should not be used. Never use 120-minute cassettes; the backing is too thin and will quickly stretch and may break. Because of their strength, tapes of 60/90 minutes are recommended for withstanding the physical strains of recording.

The Right Connections

Please exercise caution when connecting other equipment to the X-28H. Never connect the output of an amplifier to an X-28H input, for example, because you could seriously damage the recorder. Less severe problems caused by impedance mismatching can result in a loss of volume and/or frequency response. In general, microphones are low level signals and should be used on inputs 1 through 4. Rhythm machines, synthesizers and other electronic instruments are "line" level devices and can be used on all of the X-28H inputs. Electric guitars are so often customized electronically and used with such a wide variety of effects boxes, that it's impossible to state even a general rule. The best advice is: always turn the controls on all equipment down to the minimum, then gradually increase the level controls to determine whether you've made the right connections. The Specifications section lists the input and output impedances of the unit. **Never plug anything rated in watts (W) directly to an X-28H input.**

Always use the best quality cable that you can afford. This is one simple way to dramatically improve your sound, both live and recorded. Inexpensive cables often have poor shielding, unusual impedance and poor signal-to-noise characteristics.

BLOCK DIAGRAM

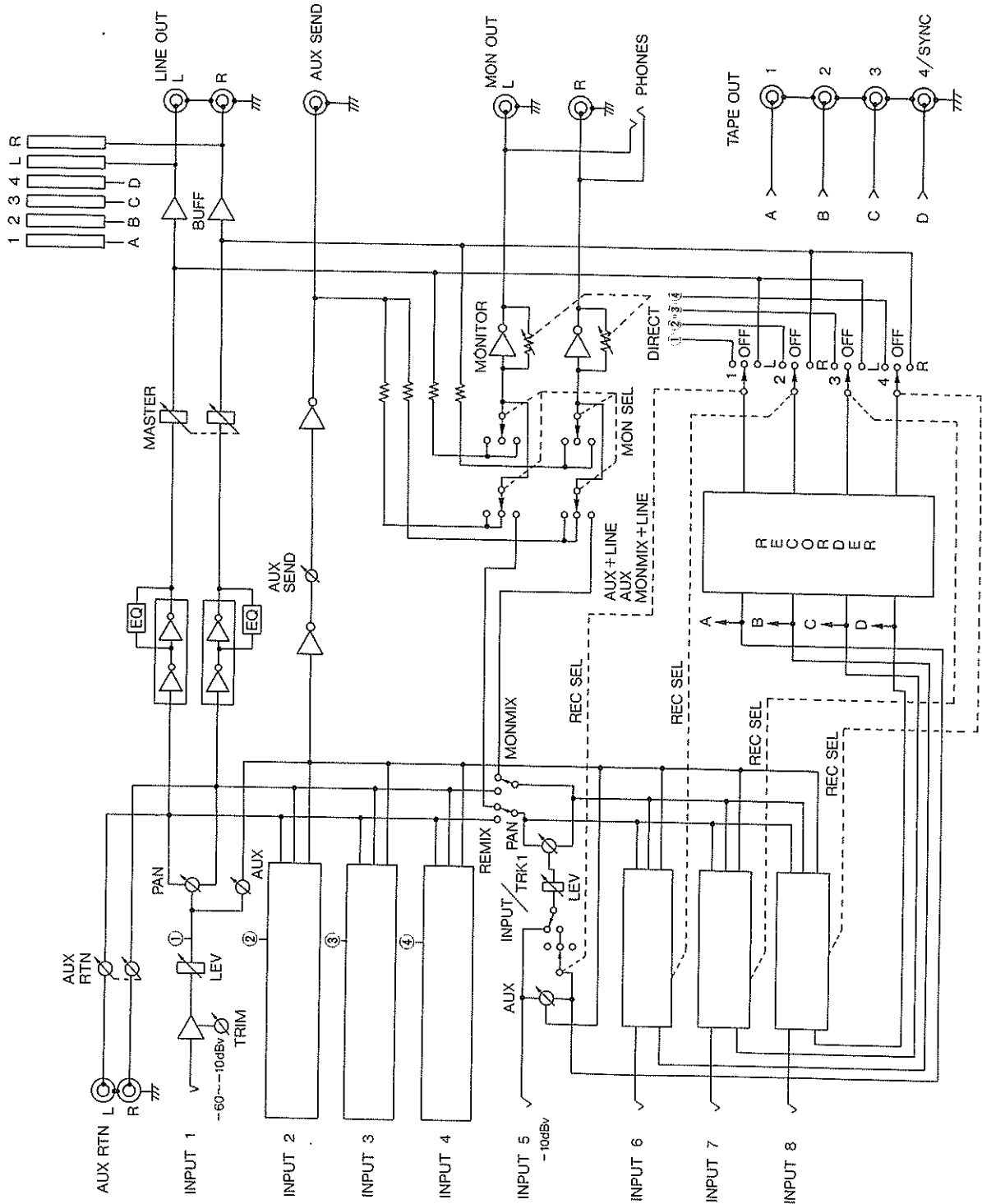

4TRACK MULTITRACKER

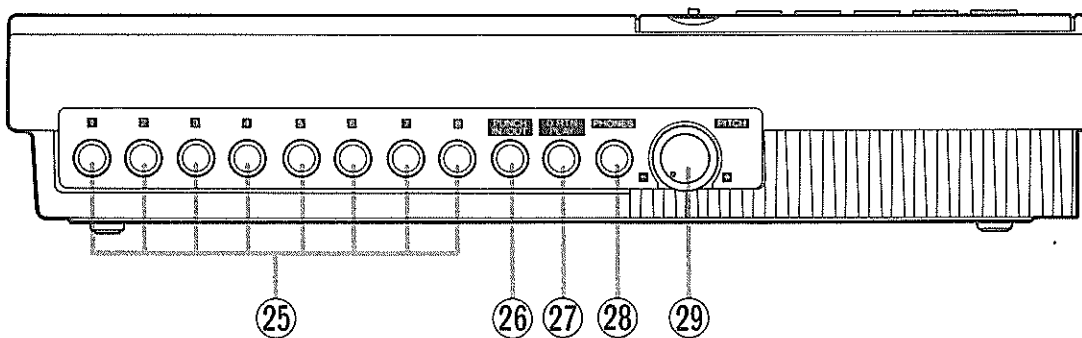
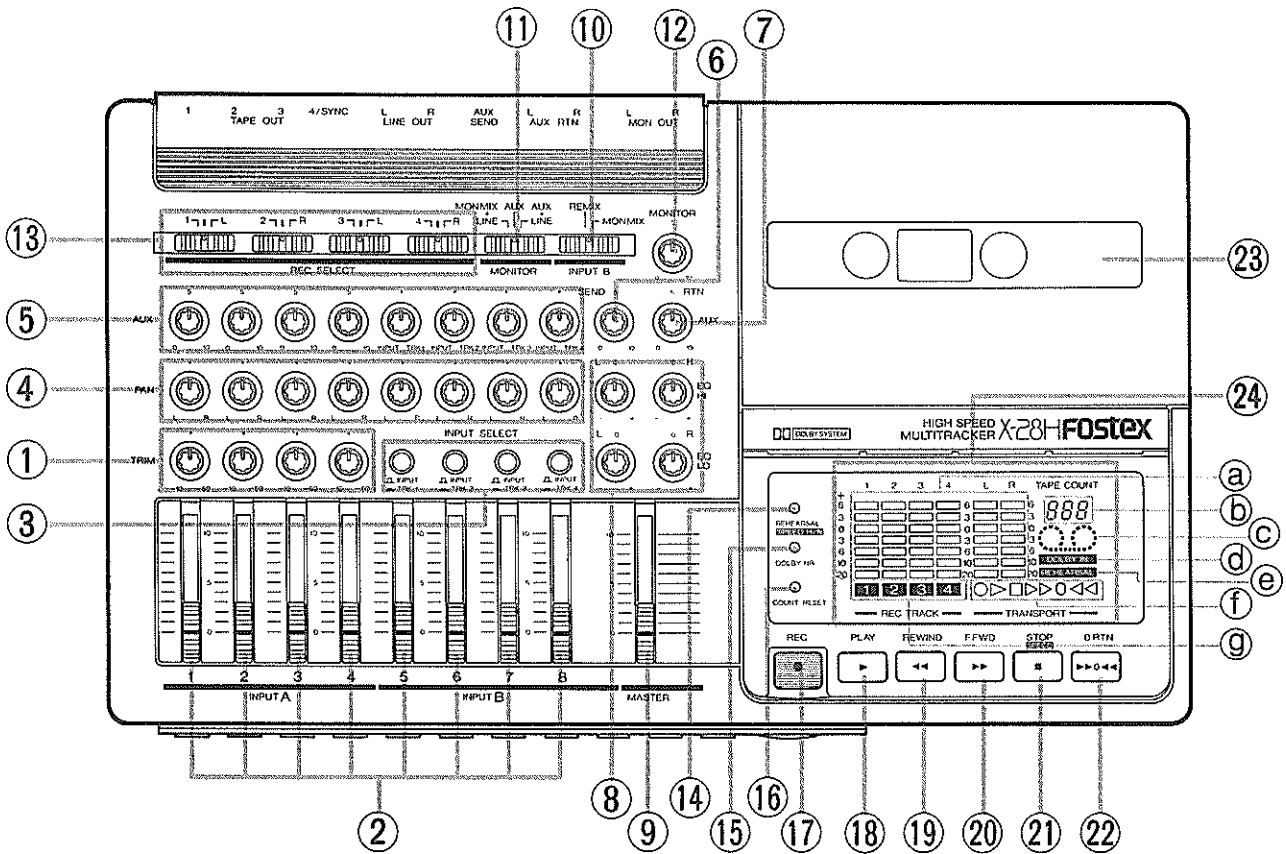
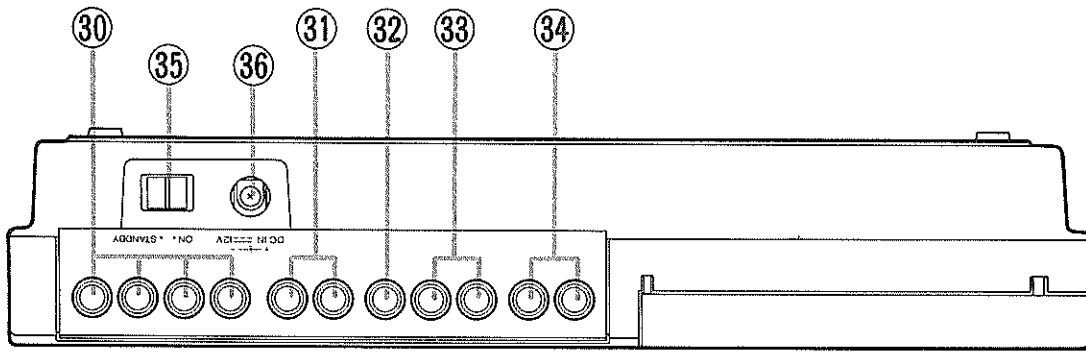

PANEL CONTROLS AND TERMINALS

(Bold words in parentheses are the names of the controls as they appear on the panel.)

PANEL CONTROLS

① INPUT TRIM 1 — 4 (TRIM)

The Trim controls are coarse controls for determining the signal levels for inputs 1 — 4. The higher settings (toward -60) are for low level sources such as microphones. The lower settings (toward -10) are for line level sources such as drum machines, keyboards and line signals from other audio equipment. These controls should be adjusted to a suitable level before adjusting the input faders of channels 1 — 4 in the INPUT A section ②.

② INPUT FADERS 1 — 8 (INPUT A, INPUT B)

The input faders are used to adjust the signal levels for the input channels. The INPUT A faders control the levels of input channels 1 — 4. The INPUT B faders can be switched to control the levels of either input channels 5 — 8 or recorded tracks 1 — 4; switching between the two functions is done with the INPUT SELECT buttons ③.

③ INPUT SELECT SWITCHES 5 — 8 (INPUT SELECT)

These two-position switches determine the signal source to be sent to the INPUT B faders ② for channels 5 — 8. When INPUT SELECT ③ is set to INPUT, the faders control channel inputs 5 — 8; when set to TRK, the faders control the recorded tape tracks 1 — 4. (Fader 5 controls tape track 1, fader 6 controls track 2, etc.)

④ CHANNEL PAN CONTROLS 1 — 8 (PAN)

The channel pan controls determine the left and right balance of the respective input signals (1 — 8) as they are sent to the stereo buss. (For more details, see "Buss," page 17.) They also determine the stereo balance of the tape tracks when the INPUT SELECT switches are set to TRK.

⑤ AUX SEND CONTROLS 1 — 8 (AUX)

The AUX SEND controls are used to send the respective input signals (or tape tracks, if selected) to the AUX SEND jack ⑩. Generally, these are for sending the signals to signal processors, such as digital reverb units or multi-effect devices. The AUX SEND controls are independent for each channel, and are used to provide a mono mix signal which is sent to the AUX SEND master control ⑥. (For more details, see the section AUX (Auxiliary) Send and Return, page 20.)

The AUX SEND controls for channels 1 — 4 differ slightly from those for channels 5 — 8, as described below.

AUX SEND CONTROLS 1 — 4

The controls for input channels 1 — 4 are post-fader; they determine the amount of signal that is sent after the input fader.

AUX SEND CONTROLS 5 — 8

The AUX SEND controls for input channels 5 — 8 are pre-fader; they determine the amount of signal that is sent before the input fader. They are dual-function controls that send either the signals of the input channels or the tape tracks, depending on which direction they are set.



When set toward INPUT, they can be used to send the selected input signal (5 — 8) to signal processors, such as digital reverb units or multi-effect devices.



When set toward TRK (TRK 1 — TRK 4), they can be used to send the selected tape tracks to a signal processor, or can be used as level controls for monitoring.

Turning the control all the way to the left sends the selected input channel at full volume, while turning the control to the far right sends the selected tape track at full volume. The center position is "0," or no signal sent. (For more details, see the section AUX (Auxiliary) Send and Return, page 20.)

⑥ AUX SEND MASTER CONTROL (SEND)

This control determines the overall level of the mixed signal output of the individual AUX SEND controls ⑤, via the AUX SEND jack ⑩.

7 AUX RETURN CONTROL (RTN)

The AUX RETURN control determines the level of the signal that is received at the AUX RETURN jacks (8). This is normally used to control the amount of effect processing (sent via AUX SEND (5) and (7) that is "returned" to the X-28H.

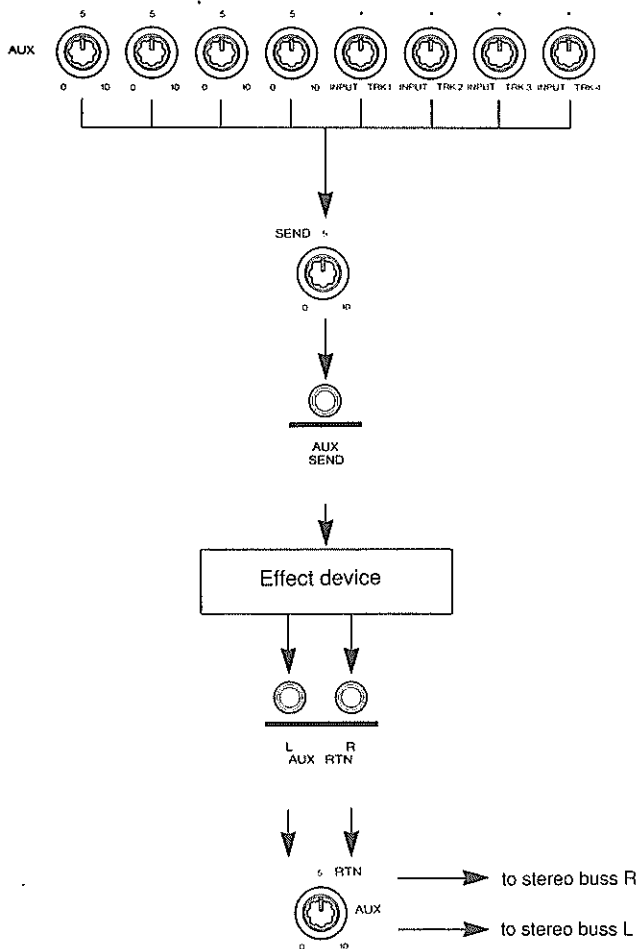

8 EQUALIZER CONTROLS (EQ HI, EQ LO)

These controls provide two-band equalization (high and low) for the stereo mix. The controls come after the input faders and before the stereo master fader.

9 STEREO MASTER FADER (MASTER)

This ganged slide control determines the overall output level of the stereo buss — the signals sent to the LINE OUT jacks (9).

10 INPUT B SELECT SWITCH (INPUT B)

This switch determines whether the stereo signal from the INPUT B channels is sent to the stereo buss or to the monitor buss. The switch has two positions: REMIX and MONMIX.

REMIX

This position sends the signal to the stereo buss. Normally, REMIX is used in most recording situations, including recording of input signals connected to channels 5 — 8, ping-pong recording and mixdown.

MONMIX

This position sends the signal to the monitor buss (the monitor out and headphone jacks). Since this switch comes before the MONITOR select switch in the signal path, the MONITOR select switch must be set to MONMIX + LINE for the signal to be heard.

11 MONITOR SELECT SWITCH (MONITOR)

This switch determines which signals are sent to the monitor out and headphone jacks. The switch has three positions: MONMIX + LINE, AUX and AUX + LINE.

MONMIX + LINE

This position sends a mix of two signals to the monitor buss: 1) the stereo signal of the INPUT B channels (when MONMIX is selected with the INPUT B select switch (10)), and 2) the signal of the stereo buss.

AUX

This position sends a mono mix of the AUX SEND signal to the monitor buss.

AUX + LINE

This position sends a mix of the mono AUX SEND signal and the signal of the stereo buss.

The following chart lists the settings for the INPUT B and MONITOR switches as used in the various recording operations of the X-28H.

Operation		INPUT B Switch	MONITOR Switch
Recording	Recording to channels 1 – 4 only	MONMIX	AUX (fixed center position), or MONMIX + LINE (stereo monitoring)
	Recording to channels 5 – 8	REMIX	AUX (or, in the case of stereo recording: MONMIX + LINE)
Overdubbing	Rehearsal	MONMIX	AUX + LINE
	Take (recording)	MONMIX	AUX
	For monitoring recorder output in stereo	MONMIX	MONMIX + LINE
Ping-pong Recording	Rehearsal	REMIX	MONMIX + LINE
	Take (recording)	REMIX	AUX
Mixdown	For sending stereo signal via LINE OUT jacks to master recorder	REMIX	MONMIX + LINE
	For sending stereo signal via MON OUT jacks to master recorder, especially in tape sync applications	REMIX	AUX + LINE

**12 MONITOR LEVEL CONTROL
(MONITOR)**

Determines the overall output level sent to the MON OUT jacks 24 and PHONES jack 25.

**13 RECORD TRACK SELECT SWITCHES
(REC SELECT)**

These three-position switches select the track(s) to be recorded. Setting the switch to the numbered position (1, 2, 3 and 4) selects the respective tape tracks; these are direct record settings that bypass the PAN and EQ controls. Setting the switch to the center position disables recording. Setting it to L (left) or R (right) selects the respective signal of the stereo buss for recording. The signal is recorded to the track number indicated on the switch. (For example, if the first REC SELECT switch is set to L, the left signal of the stereo buss will be recorded to track 1.) This setting is particularly useful for recording multiple inputs sent on the stereo buss to a single track.

**14 REHEARSAL SWITCH
(REHEARSAL/SPEED/H/N)**

This switch is used for disabling/enabling recording during punch-in recording. It also lets you hear the punch-in and punch-out as you rehearse, without erasing the original track. (Rehearsal mode is effective only when in the high speed mode and does not function in normal speed.) The [REHEARSAL] indication in the display lights up when in the rehearsal mode. The tape speed can be switched from high speed to normal by simultaneously pressing the rehearsal key and the STOP/SPEED button 21 when the transport is stopped. (The [REHEARSAL] indication in the display flashes.) To switch back to high speed, simply press the REHEARSAL switch.

**15 DOLBY* B NOISE REDUCTION SWITCH
(DOLBY NR)**

This switch turns the Dolby B noise reduction system on and off. The switch does not lock and is switched on and off each time it is pressed. Check whether the Dolby B noise reduction is on or off from the [DOLBY IN] indication in the display; it lights up when on, and goes out when off.

Dolby is set to on as a default power-on setting to give you the best possible recording and playback quality.

**16 COUNTER RESET SWITCH
(COUNT RESET)**

Pressing this button resets the tape counter 22 - b to "000."

**17 RECORD BUTTON
(REC)**

Pressing this button (after the REC SELECT switches 13 have been properly set) allows you to monitor the level of the input with the bar graph level meters 24 - a. (Pressing the REC button alone does not actually start recording, however. To record, hold down the REC button and simultaneously press PLAY.

Note: Recording can also be started. During playback, hold down the REC button and simultaneously press PLAY; if the REC SELECT switches have been properly set, recording will start.

**18 PLAY BUTTON
(PLAY)**

**19 REWIND BUTTON
(REWIND)**

**20 FAST FORWARD BUTTON
(F. FWD)**

**21 STOP BUTTON
(STOP/SPEED)**

This button stops the transport. The tape speed can be switched from the high speed to the normal speed by simultaneously pressing this button and the REHEARSAL/SPEED/H/N switch 14 when the transport is stopped.

**22 ZERO RETURN BUTTON
(0 RTN)**

Pressing this button rewinds or fast forwards the tape to the "000" position. (The zero return indicator in the display (▶▶0 or 0◀◀) will light.) This function, used with the COUNT RESET switch 16, makes it easy to "mark" a specific point in the recording and return to it automatically.

Pressing the PLAY button after pressing the ZERO RETURN button activates auto play; playback automatically begins once the tape transport reaches the "000" position. (The play indicator in the display will flash.) The PLAY button can be pressed at any time while the tape is being rewound or fast forwarded to activate the function.

23 DECK TRANSPORT

24 DISPLAY

a: BAR GRAPH LEVEL METERS

These six meters indicate the signal levels of the four tape tracks and the stereo buss.

**b: TAPE COUNTER
(TAPE COUNT)**

This indicates the current position of the tape.

c: TAPE INDICATOR

This provides visual indication of whether the tape is stopped or not and what direction it is moving. This indicator lights when a cassette tape is inserted.

d: DOLBY NOISE REDUCTION INDICATOR (DOLBY IN)

This indicator is lit when the noise reduction has been turned on with the DOLBY NR switch ⑮.

e: REHEARSAL INDICATOR (REHEARSAL)

This indicator is lit when the rehearsal mode has been engaged with the REHEARSAL/ SPEED H/N switch ⑯. It flashes when changing the tape speed from high speed to normal speed by simultaneously pressing the REHEARSAL SPEED H/N switch ⑯ and the STOP/ SPEED button.

f: TAPE TRANSPORT INDICATORS

These indicate the current status of the tape transport (i.e., whether it is stopped, or recording, or being rewind, etc.).

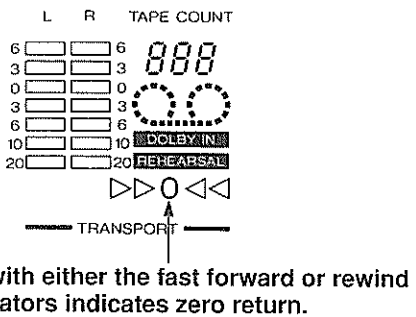
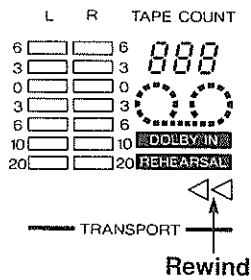
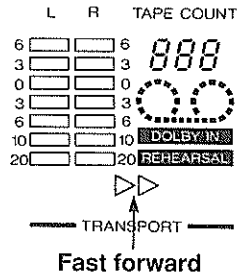
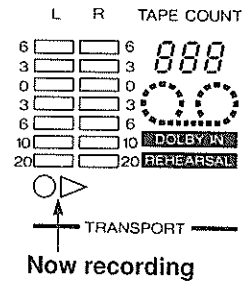

g: RECORD TRACK INDICATOR (REC TRACK)

These flash to indicate the track selected for recording. The indicators stay lit continuously during actual recording.

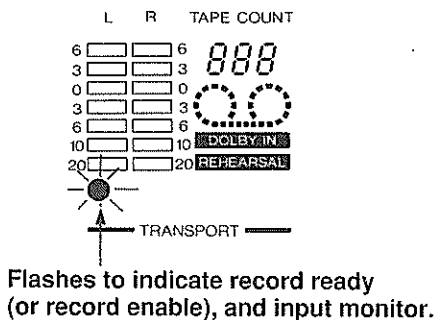
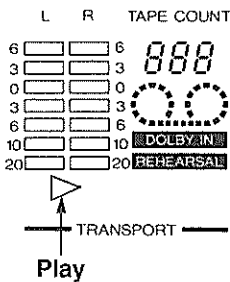
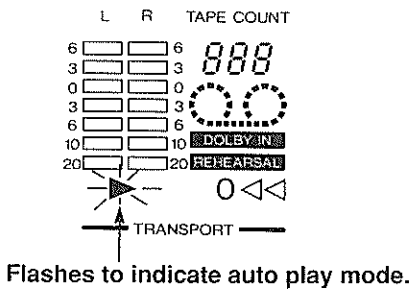
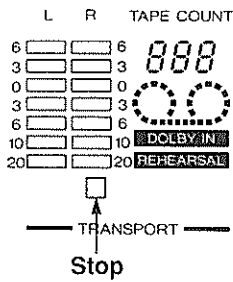

FRONT PANEL SECTION

⑳ INPUT JACKS 1 — 8 (1 — 8)

These standard 1/4" phone jacks are for connecting the signal inputs to be recorded. Inputs 1 — 4 are equipped with trim controls ㉑ and can be used with virtually any kind of source, including microphones and electric guitars. Inputs 5 — 8 are designed for use only with line level instruments.

㉒ REMOTE PUNCH IN/OUT JACK (PUNCH IN/OUT)

This standard 1/4" phone jack is for connecting an optional footswitch (Fostex 8051) for remote foot control of punch-in/out recording. (See the section Punch-in Recording, page 21.)

㉓ REMOTE ZERO RETURN/PLAY JACK (0 RTN/PLAY)

This standard 1/4" phone jack is for connecting an optional footswitch (Fostex 8051) for remote control of the zero return function. Pressing the footswitch automatically returns the tape to the "000" position and starts playback.

㉔ HEADPHONE JACK (PHONES)

This standard 1/4" phone jack is for connecting a set of stereo headphones.

㉕ PITCH CONTROL (PITCH)

The pitch control lets you finely adjust the pitch (or speed) of playback within a range of $\pm 10\%$.

REAR PANEL SECTION

㉖ TAPE OUT JACKS 1 — 4/SYNC (TAPE OUT 1 — 4/SYNC)

The signals of the four recorded tracks are output via these standard RCA pin jacks. These are used to send the individual outputs to an external mixer for greater flexibility in monitoring, or for putting different effects on each of the tracks.

㉗ LINE OUT JACKS LEFT, RIGHT (LINE OUT L, R)

The signals of the stereo buss are output via these standard RCA pin jacks. These are used to send the stereo output to a second tape recorder for making a stereo master tape.

㉘ AUX SEND JACK (AUX SEND)

The mixed signals of AUX SEND ㉙ and ㉚ are output via this standard RCA pin jack. A signal processor such as a reverb unit or multi-effect device may be connected here.

㉙ AUX RETURN JACKS LEFT, RIGHT (AUX RTN L, R)

These standard RCA pin jacks are inputs for the "returning" effects-processed AUX SEND signal; the signal is then sent to the stereo buss. Two jacks are provided, since many effect devices have stereo outputs. The jacks can also be used as auxiliary inputs, effectively giving the X-28H ten inputs.

㉚ MONITOR OUT JACKS LEFT, RIGHT (MON OUT L, R)

The signals selected with the MONITOR select switch (the same as those heard in the headphones) is output via these standard RCA pin jacks. These jacks are for connecting to an amplifier/speaker system for monitoring.

㉛ POWER SWITCH (STANDBY/ON)

This switch sets the power to STANDBY (off) or ON. The connected AC adaptor for the X-28H will not be turned off even when this switch is set to STANDBY. Because of this we recommend that you unplug the AC adaptor when not using the unit for a long period of time.

㉜ AC ADAPTOR CONNECTOR (DC IN=12V)

For connecting to the included AD-12T AC adaptor.

BASIC OPERATION



In this section, we will describe the most basic multi-track recording procedures. We've provided a specific recording example for you to follow, one that shows you how to record an initial track, then separately record additional tracks "over" the first track. After the tracks have been recorded, you'll learn how to add effects to them and mix them down to stereo for the finished product.

Because the X-28H is so versatile, a single manual cannot cover all of the possible applications. The instructions and examples that follow demonstrate the fundamentals of recording basic tracks, overdubbing, and mixdown. They are intended primarily as a guide; once you know how to operate the X-28H, you should try out your own ideas and adapt the unit to your own recording situations — each of which may require its own specific procedure.

Briefly, here is an overview of basic recording:

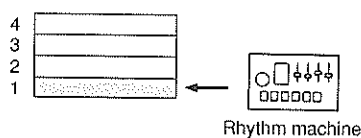
Step 1: Record a rhythm machine on track 1. (Normally, rhythm parts are recorded first to serve as a guide to ensure that subsequent parts are performed in the correct tempo.)



 — IN RECORDING MODE
 — FINISHED RECORDING

Step 2: Overdub an electric bass on track 2, while listening to the rhythm machine on track 1.

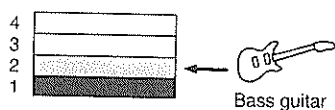

Step 3: Overdub a keyboard part on track 3 and the lead vocal and guitar solo together on track 4. (Normally, the lead parts are the last to be recorded, so that the musicians can perform those parts over a nearly complete backing band.)

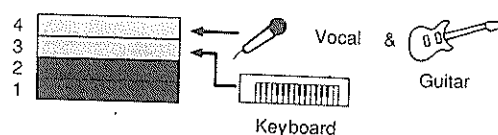

Step 4: Adjust the relative balance of the four individual parts and combine them into a stereo signal to make the final recording, which is recorded on a standard cassette deck (master recorder). A reverb effect is applied to the final recording to add depth and ambience. (You can, of course, add reverb and other effects during the original recording and/or overdubs.)

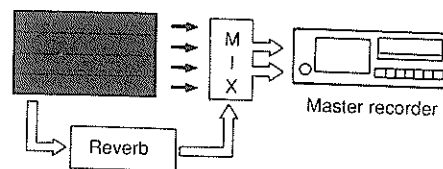

Note: The X-28H has been designed with primary emphasis on high sound quality. To ensure the best possible quality in recording and playback, always use the high speed setting. Use the normal speed only for practicing along with or learning parts from a recording.

Recording the First Track — Rhythm Machine

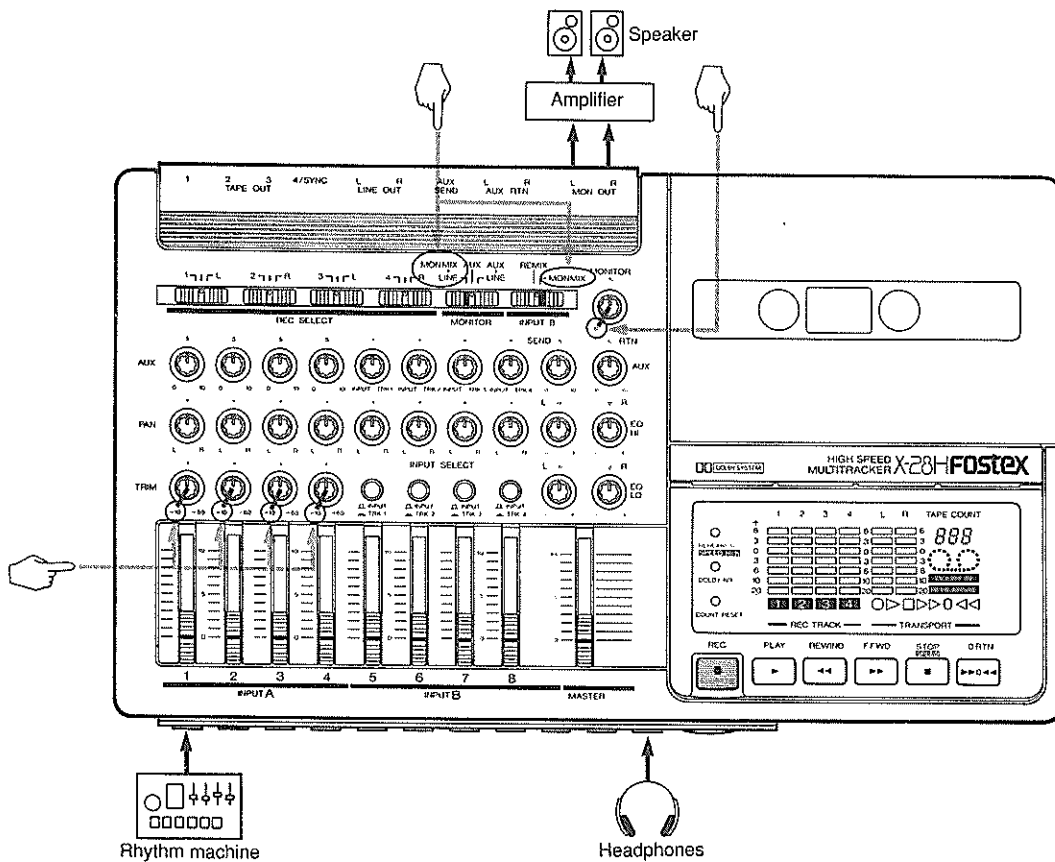

1. First, make sure that all controls on the X-28H are at their minimum or OFF settings. Most importantly, this means that all faders should be down, the MONITOR control should be at 0, the REC SELECT switches should be at the center (OFF) position, and the TRIM controls should be set to -10. Also, make sure that the MONITOR select switch is set to one of the "LINE" settings (MONMIX + LINE or AUX + LINE).

2. Make the necessary connections for listening to, or "monitoring" your recording. If you are using a set of stereo headphones, plug them into the PHONES jack. If you are using an amplifier/speaker system, connect it to the MON OUT jacks on the X-28H.

Headphone monitoring is convenient, and sometimes even necessary — when recording vocals and acoustic instruments — in order to avoid feedback from microphones. However, a good amplifier/speaker system provides the best and most accurate listening source and should be used whenever possible.

3. Plug the output of the rhythm machine into the INPUT 1 jack.

4. Switch the leftmost REC SELECT switch to 1 and press the REC button. In the display, the number 1 REC TRACK indicator and the REC indicator flash together, indicating that track 1 is set up for recording and that the signal can be monitored on the level meter for track 1.

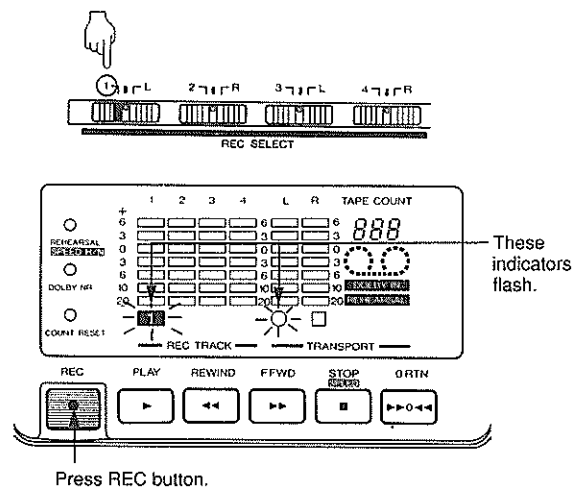

REC SELECT SWITCH AND DIRECT RECORDING:

Setting the REC SELECT switches to the numbered positions (1, 2, 3 and 4) enables direct recording. This means that the signal on the selected input channel is recorded directly to the corresponding track, bypassing the PAN and AUX SEND controls of the channel, as well as the EQ controls and MASTER fader. The REC SELECT switch must be set to the same number as the channel to which the input signal is connected. (For example, if the signal is connected to channel 1, the leftmost REC SELECT switch must be set to 1.)

- Now, adjust the level of the input signal. Bring the MASTER fader up to around 7. Do the same with the INPUT 1 fader. This is the optimum position of the faders. (The word "optimum" does not mean "maximum," but indicates the "best" position — in this case, the highest level with the least distortion.)

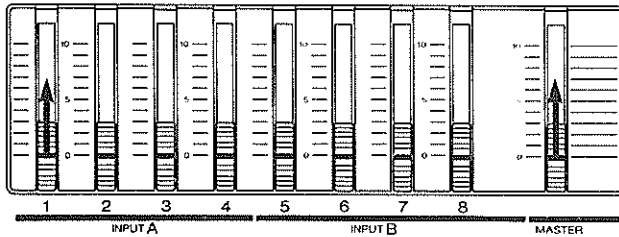

- Start the rhythm machine and increase its volume control slowly to an optimum level. Gradually increase the TRIM control (toward the -60 position) so that the meter indication for track 1 in the display peaks around 0 or +3. Make sure that the loudest signals do not consistently push the meter into the +3 to +6 range. (If you are recording something other than a rhythm machine to this track, such as a vocal or an acoustic instrument, the TRIM control may need to be set near the -60 position.)

Gradually increase TRIM

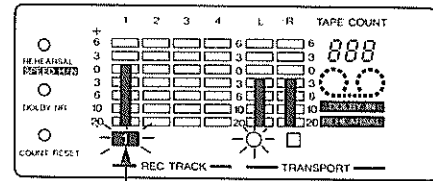
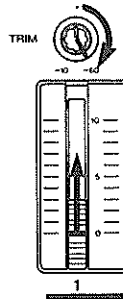

Meter should peak around 0 ~ +3

At this stage, you are setting levels so you needn't worry about content. If your level readings are constantly in the -10 to -20 range, increase the level by bringing up the faders or there will be excessive background noise. If your level readings are constantly in the +3 to +6 range, bring the level down or there will be distortion. When recording instruments with very sharp initial attacks such as bass and snare drums, you may find it necessary to set the levels at a relatively low range — for example, around -6 to -10 — just to keep the signal from distorting. A compressor such as the Fostex MN-50 will help solve this problem.

Note: The left and/or right meters of the stereo buss will light to indicate the level of the signal. Whether one or both of the meters lights depends on the setting of the PAN control on the input track; for example, if the PAN control is set to the left, the left meter will be active. The PAN setting here does not affect the recording. However, for monitoring purposes, it is best to set this at the center position.

- Next, make the necessary settings on the X-28H for monitoring. Whether you are using headphones or an amplifier/speaker system, simply turn the MONITOR control up to around 5, or to a comfortable listening level. Note that you may also have to make adjustments on all of the level controls in the recording and monitor circuits if the volume is too loud or soft.

Note: Since this first recording (basic track) will be used as a reference for all additional recordings, it's a good idea to begin with a rhythmic count-off with the snare drum before the actual downbeat or upbeat of the performance begins. (This makes overdubbing a lot easier.)

Note: Make sure that the noise reduction (DOLBY NR) switch has been turned on — both for recording and playback. This will make your recording sound as clean and clear as possible.

Monitoring

Understanding the concept of monitoring is essential to mastering the multitrack record process. To monitor a recording means to listen to it. It also means to check sound levels — aurally, over the headphones or speaker system, or visually, by means of the level meters.

One important thing you should understand about monitoring is that you can be recording a signal at one level and yet be hearing it through the monitor at a different level. This is particularly crucial, for example, if the MONITOR control is set near 0. You may find yourself cranking up the input faders and TRIM controls just to be able to hear the signal — which could result in a horribly distorted recording, and even possible damage to the recorder. For this reason, always set the monitor controls to their optimum positions first, then adjust the input levels.

Another thing to remember is that there are two different types of signals that are monitored during

the recording process: those currently being recorded (live or **input** signals) and those that have already been recorded (**tape** signals). This difference is important in overdubbing. You must adjust the levels of the individual tape signals with the faders to get the proper balance of the recorded tracks when overdubbing a new part.

The X-28H always gives you a visual monitor of the tape signals with the level meters in the display, regardless of the monitor settings. However, with direct recording (setting REC SELECT to track numbers), the input bypasses the stereo buss, and the level shown in the stereo buss meter is NOT a true indication of the level that is to be recorded to the track. Always be sure to press the REC button to enable input monitoring with the REC TRACK level meters.

For more information on monitoring, see the boxed section, AUX (Auxiliary) Send and Return, page 20.

8. Now you're ready to record. Press the PLAY and the REC button simultaneously. (The REC TRACK indicator for track 1 will be lit continuously, as will the record and play TRANSPORT indicators.)

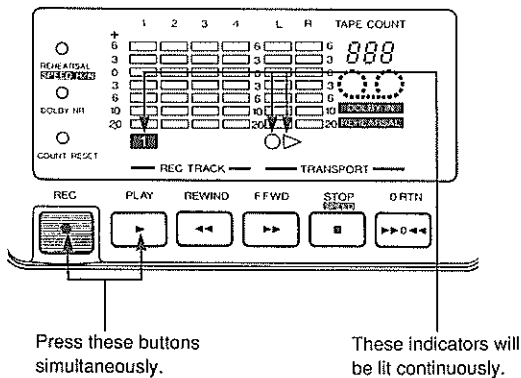

9. After stopping the recording, you'll want to listen to it and check that everything has been recorded satisfactorily. First, switch the leftmost REC SELECT switch back to the center position to disable recording. Then, press the INPUT SELECT switch of INPUT B channel 5 to select TRK 1 and bring up fader 5 to a suitable level (around 7). Doing this selects tape track 1 for playback. Set the PAN control to the center position, for optimum monitoring. Also make sure that the MONITOR switch is set to MONMIX + LINE, and INPUT B is set to MONMIX.

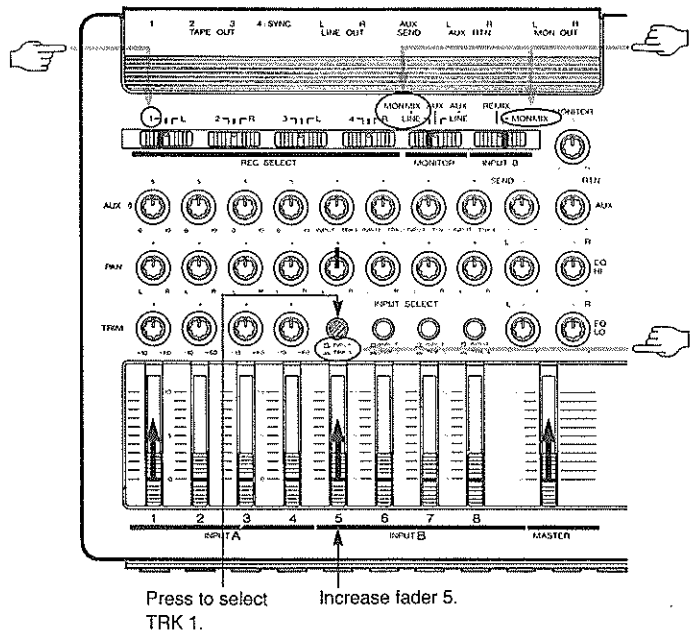

Listen to your newly recorded track carefully. If there is too much hiss or noise, the recording level might have been too low. If there is too much distortion, the recording level might have been too high. Record the track again, readjusting the settings as necessary to get the sound you want.

FOUR-TRACK SIMULTANEOUS RECORDING:

The direct recording method, used to record the rhythm machine in the above example, can also be used to record four instruments at the same time to different tracks. To do this: simply follow the above steps, setting up tracks 2, 3 and 4 for recording just as you did for track 1. If, for example, you are recording a four-piece band, record each of the musicians on a separate track, and set the levels appropriately before recording. Once you have recorded the performance, follow the instructions for mixdown in the section Mixdown and Effects Processing — Adding Reverb, page 19.

Buss

The term "buss" refers to a signal path in the mixing network of the X-28H. The stereo buss (left and right) is the main signal path of the X-28H; the PAN controls are used to direct the signals on this path.

The overall level of the mixed signals sent on the stereo buss to the LINE OUT jacks is determined by the MASTER fader.

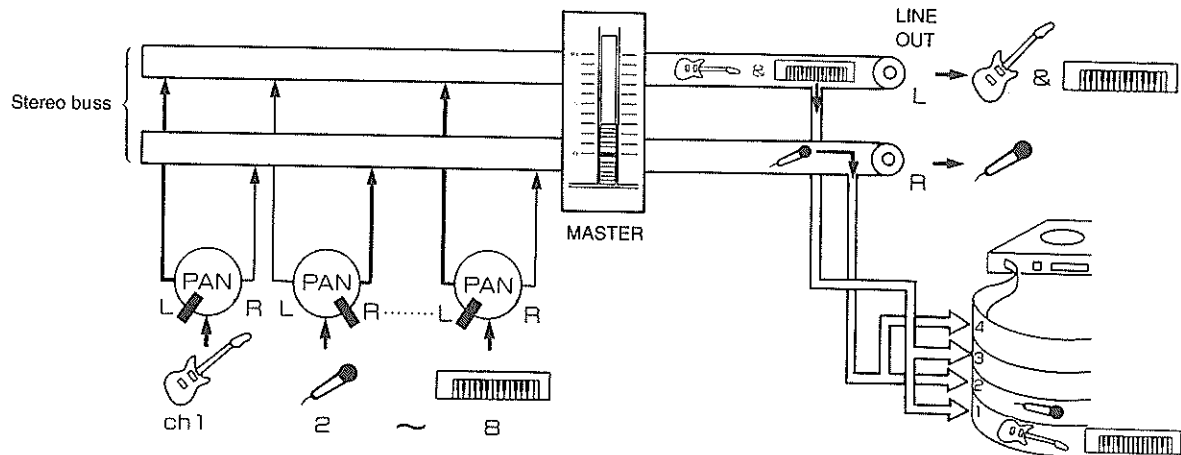

Other busses on the X-28H include the AUX buss, which sends the mixed signals to the AUX SEND jack and receives a stereo input via the AUX RE-

TURN jacks, and the monitor buss, which carries the input and/or tape signals to the MONITOR OUT and PHONES jacks.

Overdubbing — Recording Bass to Track 2 and Keyboard to Track 3

Overdubbing, as mentioned in the introduction to multitrack recording at the beginning of this manual, is the process of recording one part (track) while listening to a previously recorded part in perfect synchronization. In this example, we'll first overdub an electric bass on track 2. Once that is accomplished, we'll overdub a backing keyboard part to track 3.

1. Plug the instrument into INPUT 2.
2. Set the MONITOR switch to MONMIX + LINE, and the INPUT B switch to MONMIX.
3. Select 2 with the REC SELECT switch for tape track 2. The flashing number 2 in the display indicates that track 2 is now set up for recording. Also press the REC button to enable input monitoring with track 2's level meter.
4. Now, adjust the level of the signal as you did in steps #5 and #6 in the previous section. The MASTER fader should be at its optimum level (around 7), as should the INPUT 2 fader. Also, adjust the TRIM control for INPUT 2 to a suitable level.
5. To monitor the previously recorded track, make sure that the settings you made in steps #7 and #9 in the previous section are still intact.
6. You'll probably want to practice the bass part before you actually record it. To do this, press PLAY to play back the original recording and play the bass part as you listen to the mix of the two signals.
7. Now, record the new part by pressing the PLAY and the REC button simultaneously.

- To hear playback of the two tracks together, switch the REC SELECT switch of track 2 back to the center (off) position, then switch the INPUT SELECT button of INPUT B channel 6 to TRK 2 and bring up fader 6 to a suitable level. Check the recording by listening to it through monitor speak-

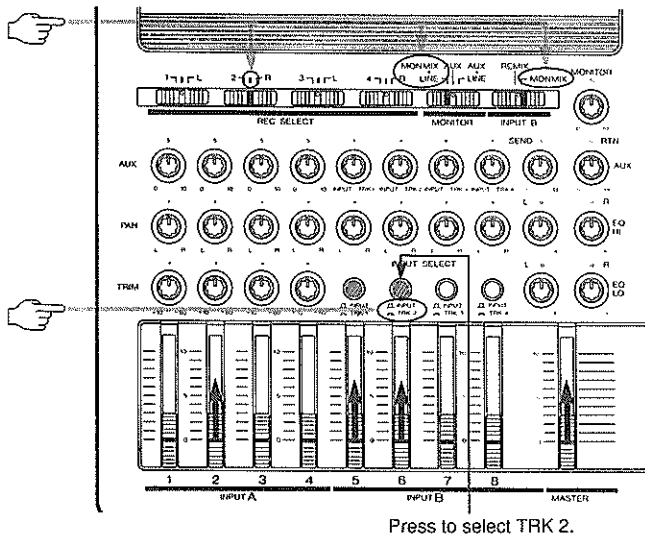

ers. Use the faders on the corresponding INPUT B channels (faders 5 and 6) to adjust the relative balance of the two tracks.

- Overdub the backing keyboard parts on track 3, following the same procedure given above, using INPUT 3 this time.

Overdubbing the Final Track — Vocal and Guitar

Now that you have recorded the basic parts of a backing band (drums, bass and keyboards) to on the first three tape tracks, you can use track 4 to record the lead parts of the song — the vocals and a guitar solo.

- In this example, since you will be recording two parts at one time, you'll need to use two input channels. Connect the vocal microphone to INPUT 1 and the guitar to INPUT 2.
- Since these inputs will be recorded on a single track, you must use the stereo buss instead of the direct recording function. To do this, set track 4's REC SELECT switch to R. Also make sure the PAN controls of channels 1 and 2 are set all the way to R. This directs both input signals to the right side of the stereo buss and records them on track 4.

- Make sure to use headphones for monitoring, to avoid feedback when recording the vocal part. The signal will be coming from the right side of your headphones, so you may want to monitor the signal from the center of the stereo image. To do this, refer to the box, MONO MONITORING IN STEREO RECORDING, below.

Note: The following instructions (step #4, in particular) assume that you are using this technique of monitoring the signal from the center. Even if you don't, though, they will still be relevant to the recording of your vocal and guitar parts.

- Make sure that the MONITOR switch is set to AUX + LINE, and that the INPUT B switch is set to REMIX. (Keep them at these settings throughout this section.)

MONO MONITORING IN STEREO RECORDING:

When recording signals over the stereo buss (setting REC SELECT switches to L or R), the PAN controls for the relevant channels must be set to the appropriate side of the stereo buss. This means, for example, that if you are recording to the right side of the stereo buss, you will hear the signals coming from only the right side of the monitor. This is fine as far as the recording is concerned, but it can be irritating to listen to — especially if you are using a set of headphones. You can eliminate this by sending the monitor signal over the AUX buss. The AUX signal is a mix that is sent in mono to both the left and right channels of the monitor.

To do this:

- Set the MONITOR select switch to AUX (or AUX + LINE), and make sure the INPUT B switch is set to REMIX.
- Turn up the AUX SEND controls on the appropriate channels. (For INPUT B channels, they should be set most or all the way clockwise to their TRK settings.) Also make sure that the master AUX SEND control ⑥ is set to a suitable level.
- With the MONITOR control at a suitable level, you can now hear the recorded tracks from both the left and right channels of your headphones or speaker system, even though the signal is being recorded over just one side of the stereo buss.

- Press the REC button to enable input monitoring with track 4's level meter, and adjust the levels of the signals. The MASTER fader should be at its optimum level (around 7), as should the INPUT 1 and 2 faders. Also adjust the TRIM controls for the inputs to suitable levels.
- Monitor the previously recorded tracks. Make sure that the INPUT SELECT switches of the three recorded tracks are set to TRK. Set the faders for the channels to suitable levels.

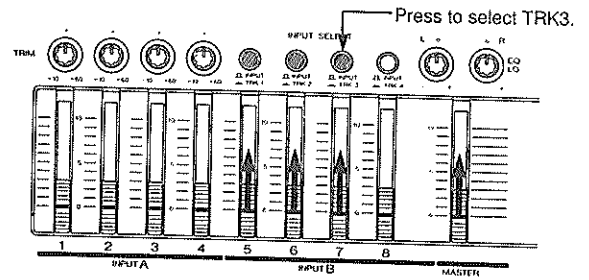

- Practice the vocal and guitar parts before recording, checking the level of the signals with the level meters. Press the REC and PLAY buttons simultaneously and record the track as usual.

Mixdown and Effects Processing — Adding Reverb

Mixdown is the process of playing several previously recorded tracks (up to four, in the case of the X-28H) and mixing them into a composite signal (stereo, in this case). It involves adjusting the balance of the individual tracks in terms of level (gain), stereo placement (pan), and depth (reverb). The resulting signal — the finished recording — is normally in stereo, and is copied to a master recorder, usually a stereo cassette deck.

Note: This example assumes that you have a reverb unit, preferably one with stereo outputs, and a master recording deck (cassette, reel to reel, or DAT).

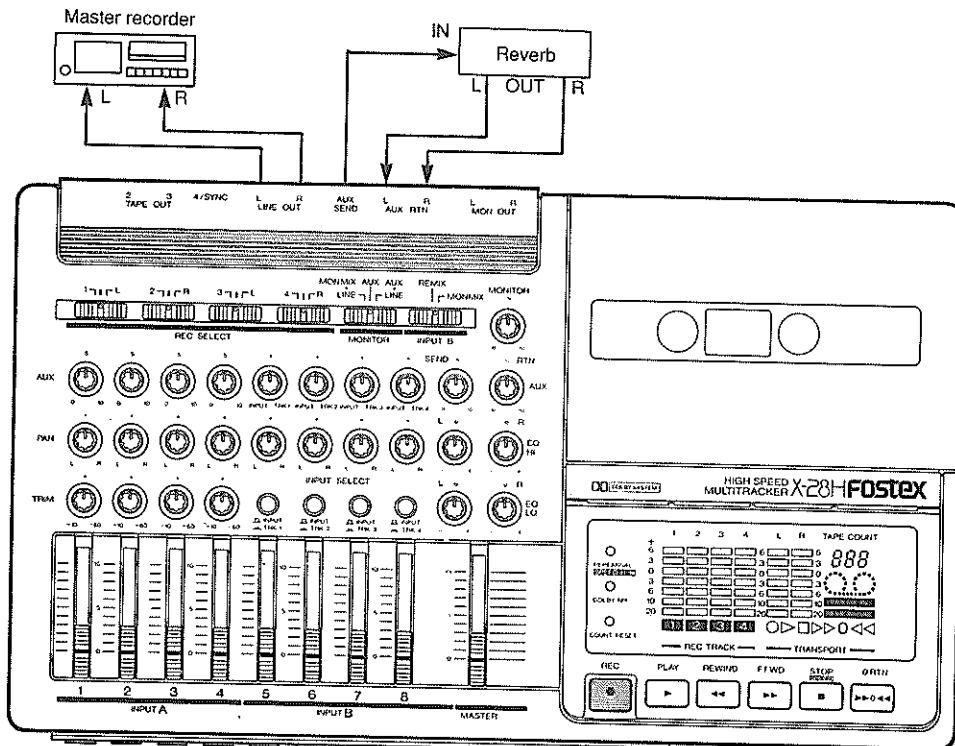

1. Patch the LINE OUT jacks to the line inputs of the master recorder (standard cassette deck), making sure that the L and R designations on both machines match.
2. For effects processing, patch the mono AUX SEND jack to the input of the reverb, and patch the stereo output of the reverb to the AUX RTN jacks.
3. Make sure that all four REC SELECT switches are set to off (center position), and set the INPUT B switch to REMIX.
4. Switch all the INPUT SELECT buttons to TRK, and set the MASTER fader to its optimum position (around 7).
5. Temporarily set all the INPUT B faders to their optimum positions, as well. Also set all PAN and EQ controls to the center.

The fader, pan and EQ settings you make here may not be the ones you ultimately use for mixdown, but they provide a good reference point to work from while setting initial levels.
6. Start playback by pressing PLAY and adjust the overall stereo output level with the MASTER fader. You can also use the EQ controls to adjust the overall tone of the stereo signals. Adjust the levels of the individual tracks with the INPUT B faders and the stereo position with the PAN controls.

7. Now that you've made the basic mixdown adjustments, try adding some reverb to the recording. First, make sure that all AUX SEND controls for the tape tracks are set to 0 (center position). Also, set the AUX RTN and AUX SEND master controls to around 5. These are merely temporary reference settings until you start playback again and begin experimenting with various reverb levels.
8. Play the recording again and adjust each of the individual AUX SEND controls of the tape tracks in succession, to achieve the right reverb balance. Keep in mind that the center position of the AUX SEND controls for the tape tracks is 0, and the maximum setting is all the way to the right. (Turning the controls to the left will have no effect in this situation.)

The AUX SEND signals of each track are mixed to a mono signal and sent to the reverb unit. They are processed there and returned to the X-28H's stereo buss, where they are mixed with the original "dry" sound.

Note: The reverb unit itself will probably have input and output level controls which should be adjusted in conjunction with the send and return controls on the X-28H.

AUX (Auxiliary) Send and Return

The AUX buss is an additional signal path that lets you connect external signal processing devices to the X-28H. The most common use for AUX send and return would be for applying varying degrees of reverb (or any other effect) to the individual tape tracks during mixdown. Another use would be to apply an effect to the input channel signal during recording.

The SEND signals of each track are mixed to a mono signal and then sent to the signal processor via the AUX SEND jack. There the mixed signal is processed, and returned to the X-28H's stereo buss, where they are mixed with the original "dry" sound.

The level of each individual channel's AUX SEND is the first control that determines how much effect is applied. The next control is the master AUX SEND control. Finally, the AUX RETURN control determines the level of the processed signal that is received by the X-28H.

USING A MONO AUX RETURN:

If the reverb unit you're using has only a mono output, connect it to one of the INPUT A channels and set the PAN control of the channel to the center position. Also, make sure that the AUX control of that

channel is set to 0, and that the fader and TRIM control are set to suitable levels.

USING THE AUX SEND FOR STEREO MONITORING:

You can also use the AUX SEND controls to send signals to the monitor buss. This is useful for keeping the monitor signals in the center when using stereo recording. Make sure the master AUX SEND control and the individual AUX SEND controls on the appropriate channels are turned up. Monitor the tape tracks by turning the AUX SEND controls on the INPUT B channels toward TRK.

USING THE AUX RETURN JACKS AS ADDITIONAL INPUTS:

The two AUX RETURN jacks can be used to expand the number of available inputs on the X-28H to ten. This allows you to simultaneously record up to ten sources. However, doing this forces you to sacrifice control over the panning of the two additional inputs (one will be sent to the left, the other to the right of the stereo buss). It also eliminates the use of the AUX buss for effects processing, at least at the time those sources are being recorded. (You can, of course, use the AUX buss for effects at mixdown.)

You will probably want to repeat playback several times to get the best mix for recording. Once you are ready to record the results, follow these basic steps:

9. Use the stereo meter indications on the X-28H's display and the MASTER fader to set up the proper signal level that will be sent to the master recorder.
10. Set the record level controls on the master recorder so that a 0 meter reading on the X-28H will produce a corresponding 0 reading on the master recorder.

Punch-in Recording

Punch-in recording is the process of re-recording over a specific portion of a recorded track. Normally, this is used to fix a bad note in an otherwise acceptable performance. Rather than record the entire track all over again and take the chance that the performance as a whole will suffer, it's often easier — and better — to fix only the mistake(s). Other uses of this technique are to erase minor timing errors (for example, someone starts a part too soon or continues it too long) or to eliminate unwanted sounds from an open mic (loud coughing or inhaling).

This technique is also used to take advantage of non-recorded portions of a track. To illustrate, let's say you've recorded a guitar solo in the middle of a song. Except for that part, the track with the solo is silent. You might want to add some percussion parts to those sections where the guitar is not playing. Punch-in recording is the perfect way to do this.

You can use the panel controls to execute punch-in recording during playback. To do this, while the X-28H is running, hold down the REC button and simultaneously press PLAY at the point you wish to start recording; if the REC SELECT switches have been properly set, recording will begin. Press the STOP button to stop recording.

However, if you are playing an instrument or for some reason need to be a distance away from the recorder, you may find it difficult to use the panel controls for punch-in recording. For this reason, the X-28H features a special PUNCH IN/OUT jack that allows you to control punch-in recording with a footswitch, so that you can turn the recording function on and off — without having to take your hands from your instrument. By also connecting a second footswitch to the 0 RTN/PLAY jack, you can punch-in, automatically rewind and playback, and even re-record a passage without touching the panel controls.

11. Place the master recorder in record mode, press PLAY on the X-28H, and record your mixdown.

Note: You may have to consult the owner's manual of your master recorder for more detailed information about setting levels and making recordings on that deck.

Note: If you want the master recording to fade in or fade out, you should execute these from the MASTER fader on the X-28H, not the master recorder.

Timing is all-important with punch-in recording and you must be very careful to punch-in and punch-out at precisely the right places. If you punch-in too early or punch-out too late, you could ruin the very thing that you're trying to fix! As a rule of thumb, try not to punch-in and punch-out at crucial points in the recording, such as in the middle of a instrumental or vocal phrase. For example, if there's a mistake in the second chorus, re-record the entire second chorus.

It's also very important that you match the level and feel of the punch-in/out recording to the pre-recorded performance; otherwise, it will be obvious that the final recording was not made continuously.

This example assumes that all four tracks have been recorded (like the example in the Basic Operation section on page 13). All four tracks will be monitored and the punch-in will be made to track 4.

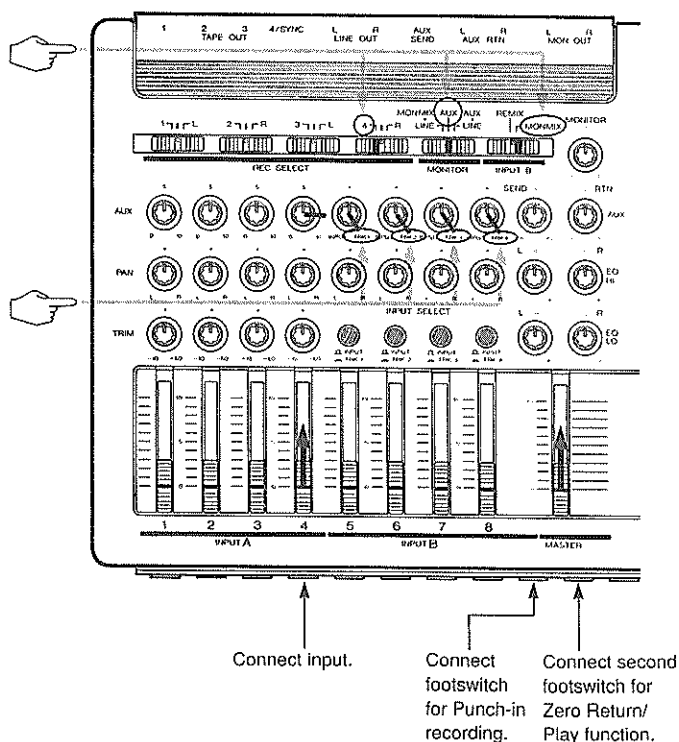

To use punch-in/punch-out recording with the footswitch:

1. Make the connections shown in the illustration above. In this example, we will be recording direct to the track, so the input is connected to channel 4. The second footswitch connected to the 0 RTN/PLAY jack is optional.
2. Make the settings necessary for monitoring the previously recorded tracks, as shown above. Set all the INPUT SELECT switches to TRK and turn the AUX SEND controls for the tape tracks to their TRK settings. Also make sure that the MONITOR switch is set to AUX, the INPUT B switch is at MONMIX, and the master AUX SEND and MONITOR controls are set to suitable levels. (Since we are using the AUX SEND to monitor the tape signals, the faders on the channels can be set to 0.)
3. Select the track for recording with the REC SELECT switch. (Either direct or stereo buss recording can be used.) The appropriate REC TRACK indicator will flash.

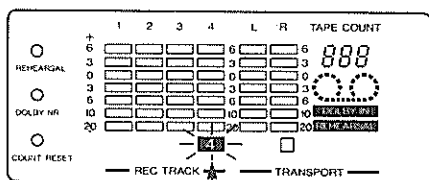

Track 4 indicator flashes.

4. Press the REC button to enable input monitoring, then set the level of the input track. Set the AUX SEND control for the channel to a suitable level so that you can hear the input signal. Once you've set

the level, be sure to press REC again to turn input monitoring off. (If you don't, pressing the footswitch once will not execute the punch-in. For this reason, ALWAYS make sure the REC indicator in the TRANSPORT display is off before attempting a punch-in.)

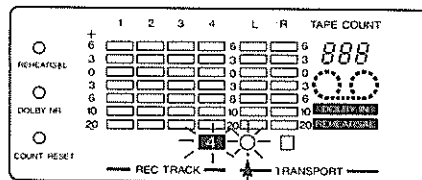

This flashes to indicate input monitoring; press REC to turn off before punch-in recording.

5. Use the rehearsal function (described below) to practice the punch-in and punch-out. Listen carefully to the levels of the tape signal and the signal to be recorded as you practice and adjust them as necessary.

The rehearsal function lets you switch monitoring between the tape track and the new part, making it easy to compare levels.
6. When you're ready to record, press the rehearsal switch to turn off the rehearsal function, then press PLAY.
7. As you listen to the previously recorded part, press the footswitch at the point you wish to start recording or punch in. The previously recorded part will be erased and replaced by the current part.
8. Press the footswitch again to stop recording or punch out.

USING THE REHEARSAL FUNCTION (High Speed Mode Only):

The rehearsal function is also an important part of footswitch-controlled punch-in recording. When the rehearsal function is engaged (its indicator in the display will be lit), pressing the footswitch does not turn the recording function on and off. Instead, it allows you to practice the punch-in recording (without erasing the original track), and to hear the new part replacing the

original in the monitor, just as if you were actually recording.

When the REHEARSAL switch is turned on, the X-28H mimics the punch-in recording process by switching the monitor between original track and the part to be punched-in with each press of the footswitch.

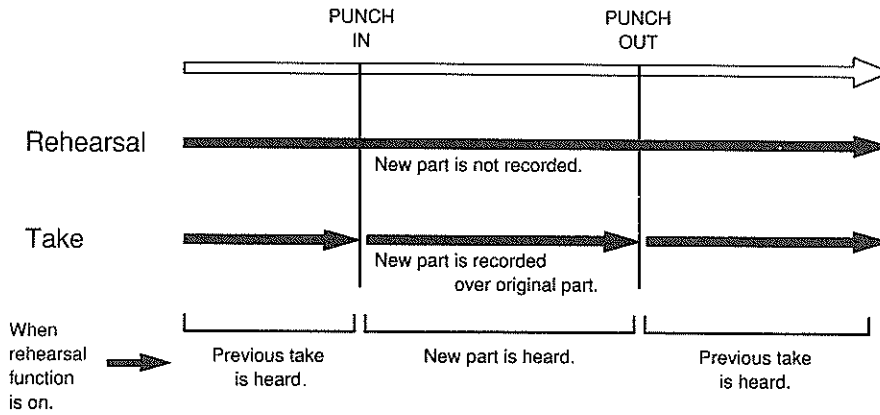

The TRANSPORT and REC TRACK indicators in the display change as shown in the following diagram during the rehearsal and punch-in/out processes.

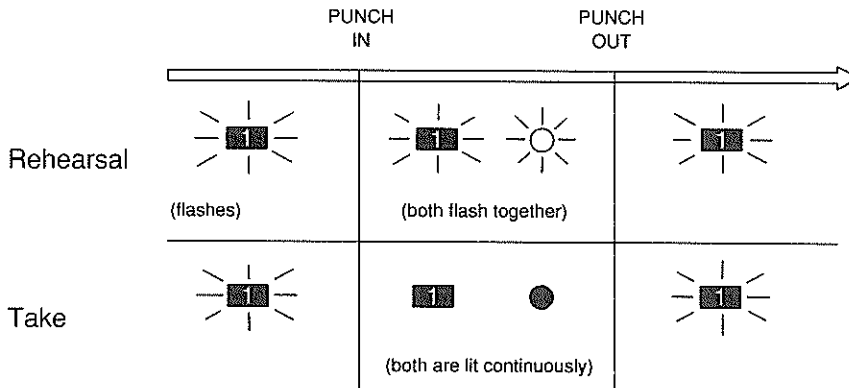

■ – Record track indicator

○ – Input monitor/record indicator

SPECIAL APPLICATIONS

In the previous section, the examples were kept as simple as possible (e.g., one instrument per track, input 1 recorded to track 1, etc.) to acquaint you with the basics of multitrack recording. However, as you'll see in this section, your X-28H has a great degree of flexibility and sophistication, and can be used in a wide variety of recording and mixing situations.

Example 1: Simultaneous Stereo Recording of Eight Sound Sources

The flexible mixing controls of the X-28H allow you to make live stereo recordings using up to eight of the inputs simultaneously. This is useful in a variety of situations, from recording a live band to simultaneous mixdown/recording of multiple sound sources con-

trolled from a MIDI sequencer. The sound sources can be mixed as to level and stereo position, and can also be processed through an effects device. Here's how it's done:

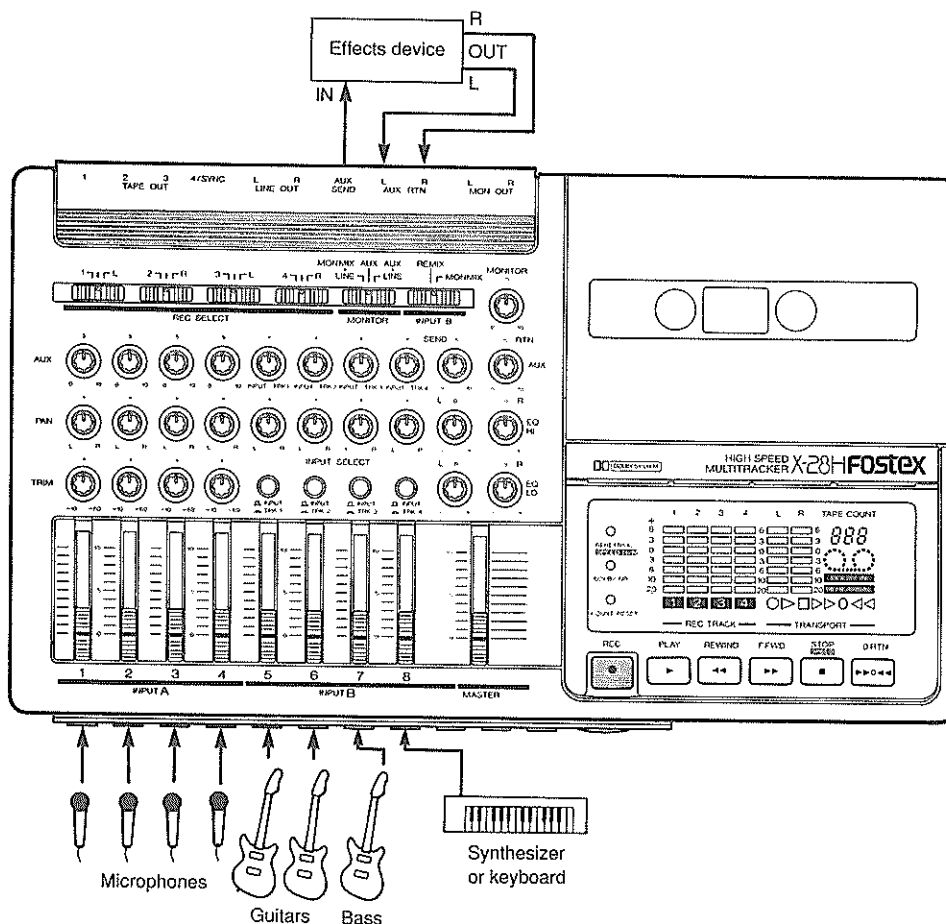

1. Connect the microphones and instruments to the input jacks, as shown in the illustration. If you are using microphones in your setup, they should only be connected to channels 1 through 4.
 2. Set the INPUT SELECT switches of channels 5 through 8 to INPUT. Also make sure that the MONITOR switch is set to MONMIX + LINE and the INPUT B switch is set to REMIX.
 3. Press the REC button to enable input monitoring. Listening to each sound source carefully, make the various settings — level, pan, and effects balance — for each input channel.
- Begin with channel 1. First, bring all of the faders on the other channels down to 0, set the MASTER fader and the fader on channel 1 to their optimum levels, then use the TRIM control to adjust the level on channel 1. Do the same for the rest of the input channels (using only the faders on channels 5—8, of course, since they have no TRIM controls).

Next, starting again with channel 1, determine the stereo position of each source by adjusting each channel's PAN control.

Finally, go through each of the channels and set the amount of reverb that is applied to each source. Follow the same procedure as you did in steps #7 and #8 in the section Mixdown and Effects Processing — Adding Reverb, page 19. When the AUX SEND controls for channels 5 through 8 is set to the center, no signal is sent to AUX SEND. Adjust the control to the left to send the signal to the effects unit. (Turning the controls to the right will have no effect in this situation.)

Note: It is a good idea to rehearse the mix as much as possible, taking special care to keep the levels in the optimum range. Keeping noise and distortion at minimum levels is a tricky business. You'll no doubt need to make further adjustments to the levels and the other controls as all sound sources play together.

4. Select the recording tracks with the REC SELECT switches. Tracks 1 and 3 are dedicated to recording the left side of the stereo signal, and tracks 2 and 4 are dedicated to the right side. Choose one track for each stereo side (e.g., 1 and 2, or 3 and 4). To select a track for recording, set the appropriate switch to the L or R position. (For this example, switch REC SELECT for track 1 to L, and track 2 to R.)

5. Now you're ready to record. Press the PLAY and REC buttons simultaneously to begin recording. The L and R meters in the display show the output signal of the stereo buss and the meters for tracks 1 and 2 indicate the respective recording levels.

Overdubbing Tracks to the Live Stereo Recording

Since the recording above is made using just two of the X-28H's tracks, the remaining tracks can be used for overdubbing two additional sources.

This procedure is the same as that of normal overdubbing, covered in the Basic Operation section, pages 13-19. First, set the REC SELECT switches to off (center position), then set the INPUT SELECT for the recorded tracks (1 and 2, in the above example) to TRK and boost the faders so that you can monitor the playback. Finally, set up track 3 for recording, and overdub the new part. Follow the same steps in recording another part to track 4.

Note: If you are using the synthesizer plugged into channel 8 in the last example, you can record that instrument to track 3 without having to connect it to INPUT jack 3. Instead of setting track 3's REC SELECT switch to 3, set it to L. This directs channel 8's signal to stereo buss L, which corresponds to track 3.

Example 2: Ping-pong Recording — Recording Seven Parts on Four Tracks

Ping-pong recording is the process of mixing two or more recorded tracks onto an unrecorded track so that additional parts may be overdubbed. "Track bouncing" is another term for this technique. With the ping-pong technique, seven different parts can be recorded to four tracks. You can even add "live" parts while bouncing tracks, effectively letting you record ten (or even more) separate instrumental or vocal parts by yourself.

Ping-pong recording, however, requires very careful planning as to the sequence of the recording. It also requires strict attention to the sonic quality, since this technique creates second generation copies of the original recordings. In this process, some of the frequencies, especially at the upper end, tend to be diminished. There is also a slight degradation of the overall signal quality. This is a characteristic of all analog recorders.

The procedure is outlined with the following instructions and illustrations:

Step 1: Record the basic track (A) and two overdubs (B) and (C) on tracks 1, 2 and 3.

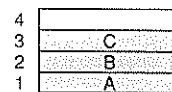

Step 2: Mix tracks 1, 2 and 3 and record them onto track 4.

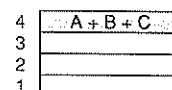

Step 3: Overdub (D) and (E) on tracks 1 and 2

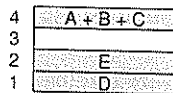

Step 4: Mix tracks 1 and 2 and record them onto track 3.

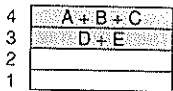

Step 5: Record (F) and (G) on tracks 1 and 2.

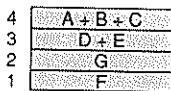

To actually execute ping-pong recording (mixing recorded tracks 1, 2 and 3 onto track 4):

1. Set the INPUT SELECT switch on the previously recorded tracks to TRK, and bring up the faders for those tracks to suitable levels. (Using Step 2 above as an example, set channels 5, 6 and 7 to TRK.)
2. Set the MONITOR select switch to MONMIX + LINE, and the INPUT B switch to REMIX.
3. Make sure that the INPUT SELECT switch of the destination channel for the recorded tracks is set to INPUT. (In this case, channel 8 is set to INPUT.)
4. Bring up the channel 8's fader to its optimum level.
5. Set track 4's REC SELECT switch to R. This sends the three recorded tracks to stereo buss R, which corresponds to track 4.
6. Set the PAN controls for channels 5, 6 and 7 to R. This is also necessary to route the three recorded tracks to the right side of the stereo buss.

Note: You may want to monitor the recording with the signal coming from the center of the stereo image. Refer to MONO MONITORING IN STEREO RECORDING on page 18 for details.

7. Press PLAY to play back the recorded parts, then press the REC button once to enable monitoring of the signals from track 4's level meter in the display. Practice the track bouncing by adjusting the levels with the faders until you are satisfied with the settings.
8. Execute the track bounce by simultaneously pressing PLAY and REC.

9. Finally, check the ping-pong recording you have just made. Set track 4's REC SELECT switch back to off, and reverse the INPUT SELECT switches, setting tracks 1, 2 and 3 to INPUT and track 4 to TRK. Play back the recording and check that the balance of all tracks is satisfactory.

Adding Live Parts to Ping-pong Recording

As we mentioned at the beginning of this section, additional live instrumental and vocal parts can be mixed in with the tape tracks you are bouncing. This example shows you how to add five sound sources to the three tape tracks — ping-pong recording a total of eight separate parts to a single track. The technique can, of course, be used with several musicians supplying the live parts. However, it is even more effective and easy to control when coupled with a MIDI sequencer and several MIDI sound sources. (See the section Tape Sync, page 28, for more on using a MIDI sequencer.)

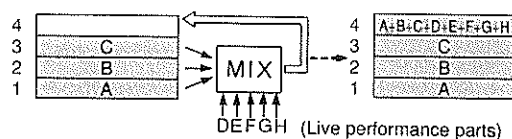

To add live parts to the previous ping-pong recording example, substitute the following instructions for steps #4 and #5 above.

1. Connect the additional sources to be recorded to the available input channels: 1, 2, 3, 4 and 8.

Note: Input channels 5, 6 and 7 cannot be used in this example, since they control the previously recorded tape tracks. However, the AUX buss can be used to mix in additional input sources. See the section, USING THE AUX BUSS IN PING-PONG RECORDING, below.

2. Bring up all faders to their optimum level. Also adjust the TRIM control for channels 1 through 4.
3. Select the destination track for the bounce by setting track 4's REC SELECT switch to R. This sends the five live tracks and the three recorded tracks to stereo buss R, which corresponds to track 4.

Note: Be careful when setting the levels of the individual channels. You should remember that the live tracks will be clearer and less noisy than the bounced tracks, so take care not to have them dominate the mix.

USING THE AUX BUSS IN PING-PONG RECORDING:

The AUX buss can be used with the INPUT B channels to record both the input signal and the tape track signal at the same time. This lets you bounce up to 11 sources a single track at one time. Here is an example in which tape tracks 1, 2 and 3 are to be bounced to track 4, with eight live sources.

1. Set up all eight input channels for simultaneous recording. Bring up the faders and TRIM controls on INPUT A channels 1 — 4, and set the INPUT SELECT switches on the INPUT B channels to INPUT, bringing those faders up to suitable levels as well.
2. Turn the PAN controls of all channels to R (corresponding to track 4).
3. Set the MONITOR select switch to AUX + LINE, so that both the AUX buss and stereo buss can be heard in the monitor. Also set the INPUT B switch to REMIX.
4. Now set the AUX SEND controls for the tape track channels, so that they will be sent to the AUX buss. In this example, turn the AUX SEND controls on INPUT B channels 5, 6 and 7 all the way clockwise to their TRK settings, and make sure the master AUX SEND control **6** is set to a suitable level. Make sure that the AUX SEND control on channel 8 is set to 0 (center position).
5. Connect the AUX SEND and AUX RTN jacks with a short RCA pin-to-RCA pin cable. This routes the signal from the AUX buss back in to the stereo buss. In this example, since we are recording to track 4, connect it to the AUX RTN R jack.
6. Finally, set up the X-28H for ping-pong recording by pressing PLAY to play back, and pressing REC to monitor the levels in the meters, then recording as usual (see steps #7 and #8 in Ping-pong Recording, page 26).

Helpful Hints for Ping-pong Recording

— Be careful when attempting to ping-pong to adjacent tracks —

For example, if you are bouncing track 3 to track 4, oscillation or feedback could occur if the level of the source track (track 3) is too high or the AUX SEND control on the track is set too high. If this happens, try lowering the send level and/or turning down the high frequency tone control. Better yet, start over with a different recording sequence.

— Use the EQ controls to compensate for sound deterioration —

A characteristic of all analog cassette tape recorders is that, in the ping-pong recording procedure (actually, any repeat recording), the highs are attenuated and the lows are accentuated. Judicious use of the EQ controls, such as boosting the highs during mixdown, will help alleviate the problem.

— Plan your recordings carefully —

Once the ping-pong recording is made, and the original tracks have been mixed together, the relative balance cannot be changed. In our example, the signal on track 4 (A + B + C) and track 3 (D + E) is each a single composite entity. Hence the importance of rehearsal and planning.

— Always save the most important parts for the final overdubs —

Normally, these would include lead vocals and lead instrumental parts. Record these last, so that you have individual control over them during mixdown (F and G in the above example).

Example 3: Tape Sync

Tape sync is the process of using one of the tracks on the X-28H to synchronize operation with a MIDI sequencer, which in turn is used to control several instruments simultaneously. A MIDI sequencer is basically a multitrack performance recorder, that allows you to record and play back MIDI-compatible instruments. Using tape sync with a MIDI sequencer offers many advantages:

- MIDI-controlled instruments need not be recorded on tape, thus freeing up track space for acoustic instruments and vocals.
- Better overall sound quality is achieved when the MIDI-controlled instruments are mixed directly to the master recorder during mixdown.

- Greater production flexibility is achieved through tape sync since you can change the MIDI-recorded musical parts and even the sounds (with the exception of tempo) right up until the final mix.

Note: Since MIDI signals cannot be recorded directly onto tape, an FSK-to-MIDI converter is required. This device converts the MIDI clock data from the MIDI sequencer into an FSK (Frequency Shift Keying) signal, which is then recorded to tape. In playback, the FSK signal is converted back into MIDI data for synchronization with the sequencer. Most modern sequencers, rhythm machines and MIDI control devices have these FSK circuits built-in; in some cases you may need to purchase an external converter.

Connection Example for Tape Sync

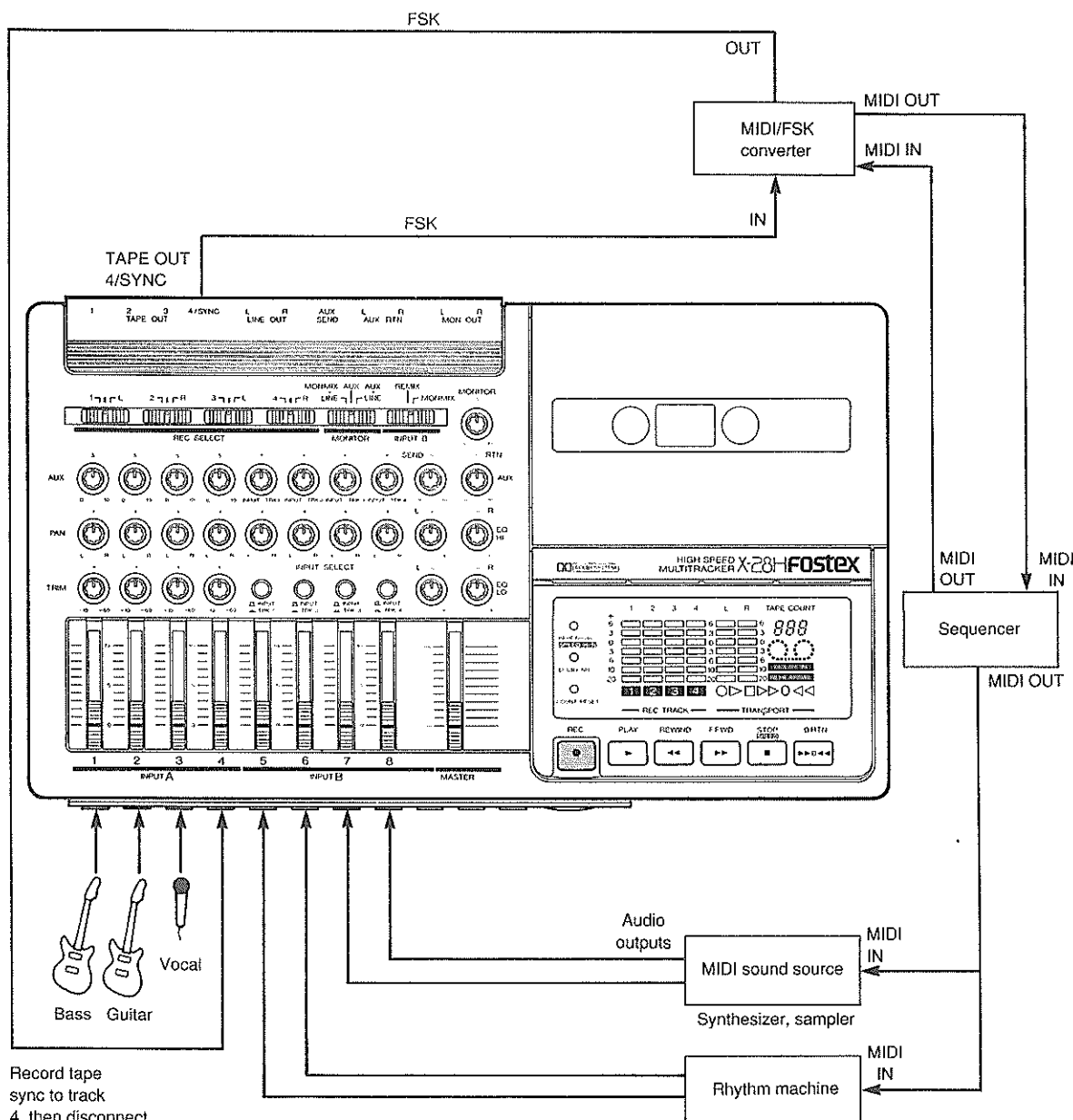

The following is a basic example of tape sync operation in which a rhythm machine and synthesizer are controlled by a MIDI sequencer synchronized to the X-28H via tape track 4. Signals recorded to the other three tape tracks are mixed with signals from the rhythm machine and synthesizer, and processed with reverb during mixdown.

1. Generally, it is a good idea to record the basic parts of the song on your sequencer first. Save the tracks of the X-28H for lead parts, such as vocals and guitar solos, that cannot be recorded on the sequencer. Also take care to program the proper tempo and song length for the sequencer, since this cannot be changed once the tape sync track is recorded.
2. Connect the sync out jack from the FSK-to-MIDI converter to INPUT channel 4, and record the tape sync signal on track 4 (using the normal recording procedure). Record the signal all the way to the end of the song. Once you have recorded it, you can remove the tape sync input from the jack.

Note: The sync tone should be recorded on one of the "outside" tape tracks (either 1 or 4) to minimize possible crosstalk with the other tracks. (Crosstalk is when the signal from one track bleeds through to an adjacent track.) Track 4 has been chosen, since track 1 is normally regarded as the first track of the recording.

Note: For detailed information concerning proper recording level for the FSK signal and the required length of the pilot tone that precedes the start of the song, refer to the owner's manual of your MIDI device.

3. To control the sequencer, the newly recorded sync tone must be sent back to the converter. Connect the TAPE OUT 4 jack to the sync in jack on the converter. (This tape output is direct and bypasses the mixing network.)
4. The exact procedure for running the X-28H and the sequencer in synchronization differs depending on the sequencer used. Generally, though, these are the steps you should follow: 1) set your sequencer to external sync (sometimes called "MIDI slave mode") and start the sequencer; 2) press PLAY on the X-28H. Once the sync tone has been received by the sequencer, it will begin running and the two devices will play in perfect synchronization.

Note: You cannot start synchronized playback (with FSK) in the middle of a sequenced song. Always rewind to well before the beginning of the sync tone and play back from that point.

5. Once you have recorded the basic parts of the song to the sequencer and synchronized the sequencer to the X-28H in the above steps, you will need to listen to the sequencer tracks as you record additional parts to the X-28H. To do this, temporarily connect the four signals from the rhythm machine and synthesizer to the INPUT B inputs 5 — 8.
6. Set the MONITOR select switch to MONMIX + LINE, and the INPUT B switch to REMIX. Set the INPUT B channel PAN controls to center.
7. Set up track 1 for direct recording. Connect the sound source to input channel 1, set the REC SELECT switch for the channel to 1, and bring up the fader and TRIM to appropriate levels.
8. Set the sequencer to external sync and start it, then press PLAY on the X-28H, as you did in step #4 above to play back the two devices in synchronization. Press the REC button once to check the input level of the new signal before you actually record. Once everything is set to your satisfaction, set the sequencer and X-28H running in synchronization again, this time pressing the REC and PLAY buttons simultaneously to begin recording. Listen to the rhythm machine and synthesizer as a guide as you record the new track.
9. Now that track 1 has been recorded, you will need to monitor it with the sequencer tracks. First, turn the REC SELECT switch for track 1 to off (center). Then disconnect the input at channel 1, and replace it with the input from the currently at channel 5. Set the fader and TRIM control appropriately.

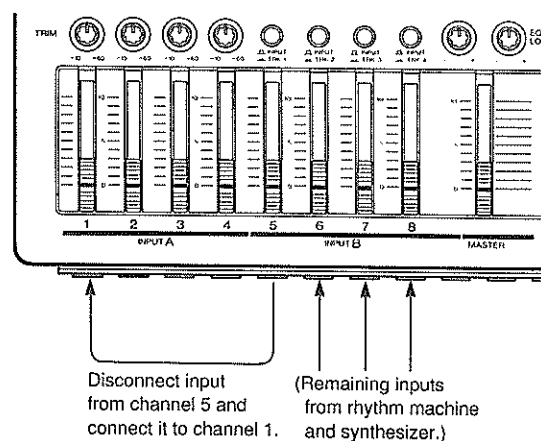

10. Set the INPUT SELECT switch on channel 5 to TRK 1, and bring up the fader to the optimum level.
11. Overdub additional parts to tracks 2 and 3 following the same procedure as in steps #9 and #10. What you are doing here is changing the inputs one by one, moving a sequencer-controlled signal input from INPUT B to INPUT A, freeing the INPUT B channels one by one so that you can monitor the tape tracks.

12. Now that you have recorded three tape tracks to augment your sequencer tracks, you can mixdown all the parts with reverb on a master recorder. To do this, make sure that the rhythm machine and synthesizer outputs are connected to the INPUT A channels, then set the levels of the signals with the fader and TRIM controls.
13. Play back the sequencer and X-28H in synchronization. Follow the normal mixdown procedure (see page 19). Adjust the level, PAN and AUX SEND

controls of all channels. Then rehearse the mixdown as necessary, and record the mix to a master recorder.

Note: Do not allow the tape sync signal recorded on track 4 to be mixed with the other signals. During this entire operation (after the tape sync signal has been recorded), make sure that the INPUT SELECT switch for channel 8 is set to INPUT and that its fader and AUX SEND control are set to 0.

Tape Sync — Combining Ten MIDI Inputs With Three Tape Tracks

The following example demonstrates a creative application of the AUX buss in making a recording with thirteen independent parts, ten from MIDI instruments and three recorded tracks. This application splits the

duties of the AUX SEND control and the AUX RTN inputs to accommodate the additional inputs, and uses the monitor buss for mastering the final recording.

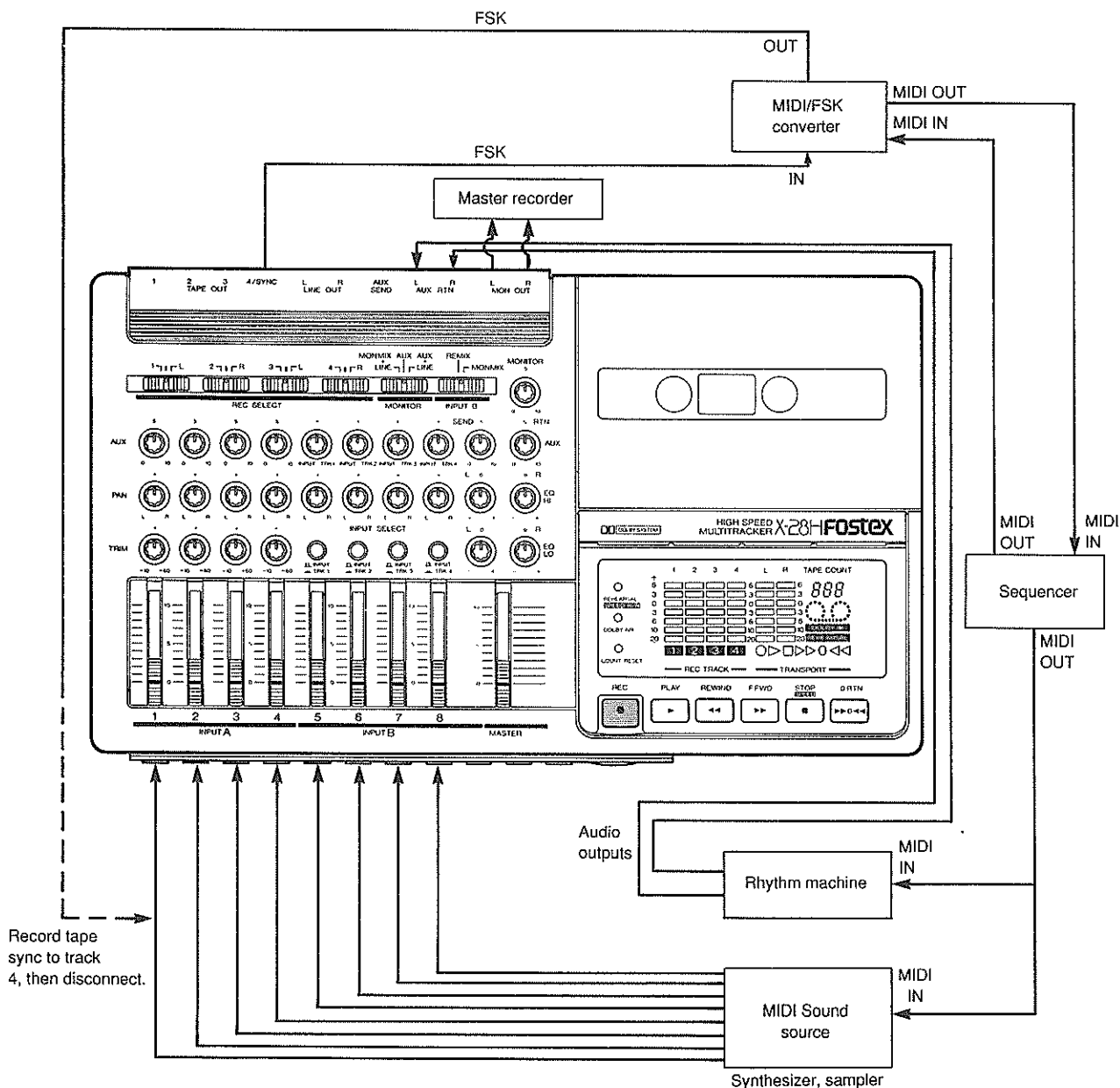

In this example, a multi-timbral synthesizer or sampler with eight individual outputs and a rhythm machine are connected to the X-28H. Bass, guitar and vocal parts are recorded to the tape tracks.

1. Set up the sequencer and X-28H for synchronized operation. (Follow steps #1 through #4 in the previous example.)
2. Connect all of the input signals; the eight synthesizer outputs to the input channels and the stereo output of the rhythm machine to the AUX RTN jacks.
3. Set the MONITOR switch to AUX + LINE and the INPUT B switch to REMIX.
4. Record the basic parts of the song on the sequencer. At least one of the sequencer parts should remain unrecorded (or disconnected from the input section) so that the tape tracks can be recorded.
5. If you are using direct recording, record the tape tracks, plugging each input in turn to channels 1, 2 and 3. (Follow steps #7 and #8 in the previous example.) Monitor the tape tracks by using the AUX SEND controls on the corresponding INPUT B channels.

Note: Depending on the requirements of the recording (and your willingness to repeatedly change the input connections), you need not strictly follow the above recording order. For example, you can program a couple of tracks for the basis of the song, record an instrument to the X-28H, program some more sequencer tracks, etc. — and mix things up in this way until you have a complete song.

6. For mixdown, connect the master recorder to the MON OUT jacks, instead of the LINE OUT jacks. This is necessary because the AUX SEND signals (of tape tracks 1 - 3) cannot be returned to the X-28H via any of the input channels or AUX RTN jacks, since all are occupied. The AUX SEND signal is instead directed to the monitor buss, along with the other line signals, and output via the MON OUT jacks. Since the AUX SEND signal is mono, the tape tracks will all be heard in the center of the stereo image.

MULTITRACK RECORDING TIPS

Recording engineering is a combination of artistic sense and technological expertise. Many schools offer programs for those wishing to be professional recording engineers. In this manual, it would be impossible to list every technique to make perfect recordings, but we can give you a few rules and suggestions that will get you started in creating your own multitrack masterpieces.

Sometimes, an hour of rehearsal will do more to improve a recording than the use of some fancy recording technique or expensive outboard equipment. Guitar superstar Steve Vai recorded his first album on a Fostex 8-track in his garage. Many of the great albums by the Beatles, Rolling Stones, Otis Redding, B.B. King and other legends were recorded on equipment whose specifications and ease of use were inferior in every way to the X-28H. In other words, do your best; the X-28H won't let you down.

— General Suggestions —

- Record and mix at relatively low sound levels. The longer your recording or mixdown session, the less accurate your hearing will be. Listening to playback at high volume for even short periods of time reduces your ability to hear high frequencies. The less high frequencies you hear, the more you tend to boost them, until you have a recording that is all highs. If you work marathon sessions, try to give your ears a five- or ten-minute rest every two hours.
- Ask others for advice. If you know someone whose sound you admire, ask them what they did to get that sound. If you know someone who has been down this road just a little longer than you have, ask them what they've learned. By the same token, share your experiences with others. No one has a monopoly on creativity or knowledge; in fact, the more you share with others, the more they'll share with you.

— Tape —

- Keep your cassette tapes at least three feet away from any magnetic fields — especially those of computer monitors, speakers, TVs and telephones — they can damage or even erase what you've recorded.
- Clearly and logically label your tapes. If your creative juices are flowing at all, you'll soon amass a whole box worth of cassette recordings. If your tapes are not labeled, you'll waste a lot of time trying to find the one you need.
- After finishing a recording on cassette, you should punch out the two record-protect tabs so as not to inadvertently erase your newly created masterpiece. (Be sure to take BOTH tabs out, since you've recorded to all four tracks.)

— Settings —

- Start all your recordings by “zero-ing” the controls — that is, setting them all to their 0, OFF or minimum position. Adjust only those controls which pertain to the operation at hand.
- When using the EQ controls to brighten the sound, the first impulse is to turn the HI control up. Keep in mind, however, that you can get a similar effect by turning the LO control down instead.
- If you haven't already done so, we suggest you take time to read through one of the “least readable” parts of the manual: the Panel Controls and Terminals section. Much of the information in the section will be obvious, but if there are some functions and settings of the X-28H that have you baffled or just plain curious, there's no better place to get more information.
- You should also familiarize yourself with the signal paths of the X-28H by referring often to the signal flow and block diagrams in this manual. These, too, are undoubtedly difficult to understand at first glance, but the effort you make in following the signal paths as you read through the instructions will pay off in a greater understanding of the entire multitrack record process.

— Recording —

- Make a blank “track chart” for your recordings and photocopy several of them. Write down what instrument or part was recorded to which track, and keep notes as to what pan, level and effects settings are needed. Each track sheet should refer to a different tape, or even a different song.
- Plan your recordings so that each successive track moves up in frequency range. In other words, record bass parts first and guitar solos and vocals last.

- Try to keep similar frequencies together, if you are combining tracks. Put bass and drums together, rhythm guitar parts with keyboards, etc.
- If you use microphones to record instruments, try positioning them in different ways. With electric guitar/bass amplifiers, try putting the microphone closer to the speaker or pointed slightly away from the center of the speaker cone. Small changes can have big effects on the recorded sound. Try different microphones; use two or even more microphones in different parts of the room. In other words, experiment. Remember, cassette tape is inexpensive.
- Always rehearse before you record. You may be tempted to speed up the process by recording immediately, or you may want to make a trial recording just to check out the basic sound. Even so, you should take time to practice both the performance and the operation steps before each take.
- Be persistent. Re-record as many times as you need to come up with the perfect take.

— Ping-pong Recording —

- Record your bass parts first if you intend to bounce tracks. High frequency sounds are the first to disappear when bouncing.

— External Effects —

- Proper reverb is essential to making a polished, professional-sounding recording, but be careful to not overdo it. If you record each track with reverb, the effect is cumulative, and could make your recording sound excessively muddy. Moreover, once you put it there, you can't get rid of it. (Exception to the rule: Creating a big, richly textured reverb sound for unison musical passages, by giving each track slightly different reverb time, amount and EQ.)
- In general, use signal processors such as reverb, echo, compression, distortion, etc. sparingly. A little can go a long way, but too much can clutter the recording.

— Connections and Other Equipment —

- Use the best microphones that you can afford. At Fostex, we are partial to our own brand of microphones. If you don't use ours, at least use the best that you can find. Tip: Use condenser type microphones for recording acoustic instruments (guitar, banjo, piano, mandolin, accordion, drums, etc.). This will give these instruments a light, airy sound. Use ribbon and tube microphones for a warm vocal sound. “Pop” covers, are sometimes necessary for vocals but they can dull the high frequencies.

- If possible, use two pair of speakers for monitoring. Get a pair of accurate mixdown speakers for reference. In addition, listen to your mix with a pair of speakers that are similar to the ones on which the music will normally be heard. Pro engineers call this monitor/real-life comparison mixing. Switch back and forth between the two sets of speakers as you rehearse your mixdown. This will help eliminate “dead” spots in the frequency response of your final mix.
- How are your cables, guitar strings, amplifier, speakers, etc.? Are they new and/or in top shape? If any of your equipment uses batteries, make sure they are fresh. Also, if your equipment is not at its best, can you borrow or rent better equipment? It's really worth it.
- Keep track of all your equipment and settings by marking them. This is especially important for your cables. Fold stickers around the ends of your cables so that you know what they are and where they go.

Be sure to use tape that doesn't leave a sticky mess, such as drafting tape; avoid masking tape and duct tape.

- If you have a lot of other equipment, such as synthesizers and signal processors, you would do well to invest in a patch bay or two. Patch bays are like telephone switchboards — they provide a control center that lets you easily connect the inputs and outputs of all your equipment. They are especially convenient if you're constantly reaching in back of bulky equipment to unplug and plug cords.
- Beware of rheostats — the electric switches that let you gradually dim or brighten your lights. They may look pleasant enough, but they can add a horrible hum to your recording. Never, under any circumstances, plug your recorder or other related electronic equipment into an AC circuit controlled by a rheostat.
- By the same token, beware of air conditioners, refrigerators, and fluorescent and neon lights; these also are sources of electronic noise and hum.

ROUTINE MAINTENANCE

In addition to the normal care required of all electronic equipment — namely, keeping it dry, clean and free of dust, and avoiding temperature/humidity extremes — the recorder section of your X-28H requires regular cleaning and demagnetizing to keep it in top operating condition.

As the tape passes over the heads and guides, and between the pinch roller/capstan mechanism, a small amount of oxide residue is left behind. This happens with all tapes and all tape recorders. After a short time, you can see the tape residue accumulating on the heads, but you cannot see the magnetism. Each requires its own cleaning procedure.

For cleaning tape residue, always keep an ample supply of cotton swabs and proper cleaning solutions. The heads, guides and capstan shaft should be cleaned only with regular isopropyl alcohol solutions; the pinch roller, with special rubber cleaning solutions. Be very careful not to get any of the alcohol cleaner on the pinch roller, since it eats away at the rubber. These cleaning agents are available at most audio equipment and musical instrument stores. You should only use cotton swabs designed for cleaning audio equipment; swabs with too little cotton can scratch the heads, while swabs that are packed too loosely can leave damaging cotton fibers in the mechanism.

Note: No organic solvents (such as lacquer thinners) should ever be used on the heads, capstan shaft and guides. Do not use silicone lubricants on the pinch roller! This will increase wow and flutter.

If you get lazy or forgetful and allow the oxide deposits to build-up, performance will suffer noticeably — especially high-end response and wow & flutter. If you have total disregard for these routine maintenance procedures, the heads could become magnetized and ruin every tape you try to play. The simplest rule to follow is: Clean and demagnetize before every session. If you regularly conduct marathon recording sessions, do it every 8 hours.

Note: For demagnetizing, use either a hand demagnetizer to demagnetize the heads of the X-28H. Demagnetizing is vital to preserving the quality of the recording heads, yet it is also a potentially dangerous operation that can destroy circuits and ruin the heads if used improperly. Follow the instructions included with your device — to the letter! Also, keep your recorded tapes away from the demagnetizer when it is in use, since they can be erased by it.

Also avoid cassette tapes with built-in or applied cleaners as they often contain abrasives that will wear out the heads of your X-28H prematurely.

Final caution:

Don't smoke! Large studios forbid smoking in the control room, and for a very good reason: the particles of dust produced by cigarettes, cigars and pipes may be invisible to you, but are like rocks and boulders to your sensitive electronic equipment.

TROUBLESHOOTING GUIDE

We know we're not perfect, but we have excellent quality control and quality assurance procedures from engineering design to manufacture and shipping. Thus, "pilot errors" are far more common than "out-of-the-box" problems.

So before you get mad at your X-28H, Fostex or your dealer, please take a few minutes to run through this check list of the most common sources of user frustration:

Problem: Initial setup — "There's no sound," or "It won't record."

1. Is the power on? Is the AC adapter plugged into both the X-28H and the proper AC outlet?
2. Are all the plugs firmly connected to the proper jacks?
3. Could the cable be faulty?
4. Are the MASTER controls turned up?
5. Are the REC SELECT, INPUT SELECT, MONITOR select and MIX/TAPE switches set properly?
6. Is the cassette tape properly seated in the compartment?
7. Are the cassette record-protect tabs missing?

Problem: "It used to work fine, now it sounds weird or bad."

1. When did you last clean & demagnetize? HOW did you last clean & demagnetize? (Insufficient or haphazard cleaning is the single most common problem encountered by our service technicians.)
2. Are you using the right kind of tape (70 μ sec EQ only)?
3. Could the problem be due to tape drop-outs or tape deterioration?
4. Is the Dolby switch ON? Did you turn it on only for recording and not for playback (or vice versa)?
5. Is the PITCH control set to the center position?
6. Are the TRIM controls and faders properly set?
7. Are the PAN and EQ controls properly set?
8. Are the input/output levels to a connected external device properly set?
9. Is there an input/output impedance mis-match?
10. Are the sequencer and/or MIDI-controlled instruments properly programmed?

If the problem persists, contact your local dealer or Fostex for the name of your nearest service facility.

SPECIFICATIONS

INPUTS (1-8)

Inputs 1-4

Microphone impedance	Less than 10 k Ω
Input impedance	20 k Ω
Normal input level	MIC -60 dBV (1mV) LINE -10 dBV (0.3V)

Inputs 5-8

Input impedance	10 k Ω
Normal input level	-10 dBV (0.3V)

AUX RTN (L, R)

Input impedance	20 k Ω
Normal input level	-20 dBV (0.1V)

LINE OUT (L, R)

Output load impedance	10 k Ω or more
Normal output level	-10 dBV (0.3V)

AUX SEND

Output load impedance	10 k Ω or more
Normal output level	-10 dBV (0.3V)

MONITOR OUT (L, R)

Output load impedance	10 k Ω or more
Normal output level	-10 dBV (0.3V)

TAPE OUT (1, 2, 3, 4)

Output load impedance	10 k Ω or more
Normal output level	-10 dBV (0.3V)

HEADPHONE OUT (STEREO)

Load impedance	40 Ω
----------------	-------------

EQUALIZER (HI, LO; L, R)

± 12 dB (at 100 Hz, 10 kHz)

RECORDING TAPE

Compact cassette C-60, C-90
IEC TYPE II for use at high bias position (TDK SA, MAXELL UD-XLII)

RECORD TRACKS

4 tracks, one direction
Simultaneous recording of up to 4 tracks

NOISE REDUCTION

Dolby B (ON/OFF Switchable)

TAPE SPEED

9.5 cm/s, 4.75 cm/s (Switchable)

WOW AND FLUTTER

$\pm 0.07\%$ (IEC/ANSI at 9.5 cm/s)

FAST WIND TIME

120 seconds (C-60 cassette tape)

PITCH CONTROL

$\pm 10\%$

RECORDING TIME

22.5 minutes (C-90 at 9.5 cm/s)

FREQUENCY RESPONSE

Mixer section
Recorder section

20 Hz - 20 kHz
40 Hz - 14 kHz (at 9.5 cm/s)

S/N RATIO

58 dB or more

CROSSTALK

50 dB or more (at 1 kHz)

ERASURE RATIO

70 dB or more (at 1 kHz)

HEADS

4-channel Hard Permalloy REC/PLAY
4-channel Ferrite ERASE

POWER REQUIREMENT

DC 12 V (11 - 15V)
(FOSTEX AD-12T AC Adaptor)
AC 120V: 13W
AC 220/240V: 15W

DIMENSIONS (W x D x H)

331 x 193 x 65 mm

WEIGHT

1.75 kg

Specifications subject to change without notice.

* Dolby noise reduction manufactured under licence from Dolby Laboratories Licensing Corporation. "Dolby" and the double-D symbol are trademarks of Dolby Laboratories Licensing Corporation.

FOStex

FOSTEX CORPORATION 3-2-35 Musashino, Akishima-shi, Tokyo, Japan 196

FOSTEX CORPORATION OF AMERICA 15431, Blackburn Ave., Norwalk, CA 90650, U.S.A.

FOSTEX (UK) LTD. Unit 1 Jackson Way Great Western Industrial Park Southall Middx UB2 4SA U.K. © PRINTED IN JAPAN SEPT. 1992 8288 312 000 IM